

DLN SERIES Instruction Manual

(Middle range) (UL File No. E193797)

1 PARTS DESCRIPTION

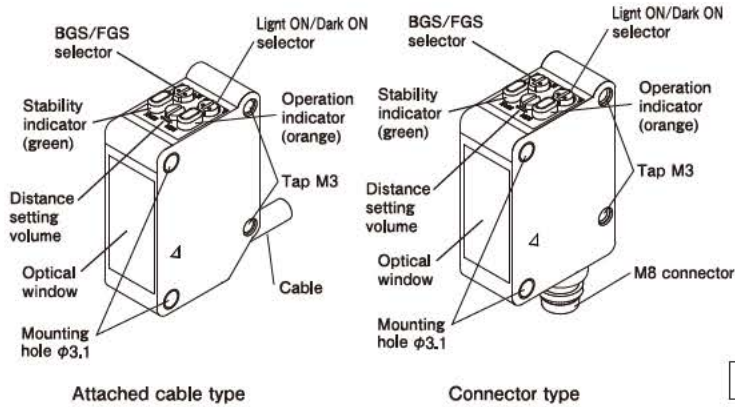

4 MOUNTING

BK-001 mounting bracket is separately available. Use M3 screws as below with a tightening torque of 0.5N·m or less.

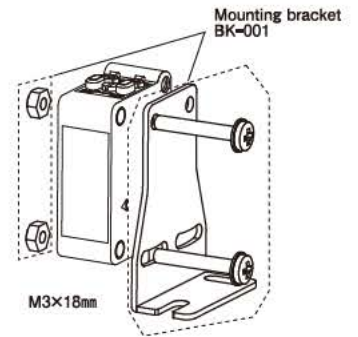

5 CONNECTION

NPN and PNP models are available.

The output configuration for each model is shown as below.

Model number followed by "P" are for PNP models.

Ex. DLN-S3RMVP or DLN-S3RMVP-J

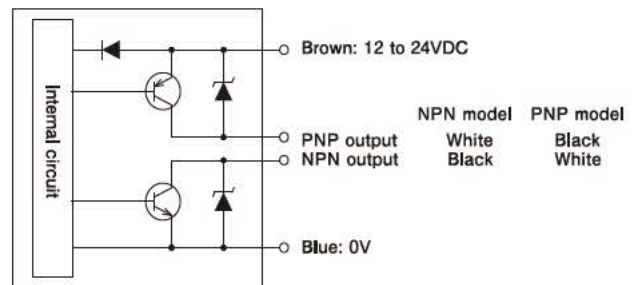

Do not use the NPN and the PNP outputs simultaneously. Insulate unused output cable.

(Pin allocation for M8 connector)

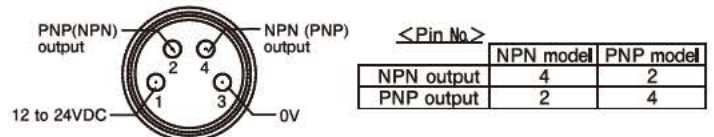

2 SAFETY PRECAUTIONS

To ensure safety, be sure to follow the precautions below.

1. Do not use this product for life or safety critical applications.
2. Do not use this product when its housing or cable is damaged.
3. Do not attempt to disassemble, repair, or modify this product.
4. Do not use this product in an environment containing flammable, explosive or corrosive gas.
5. Do not use this product in an environment exposed to chemicals or oils.
6. Do not use this product in an environment exposed to water including outdoors or under the water.
7. Use this product within the product rating and specification.
8. Do not expose this product to direct sunlight.
9. Do not use this product in an environment exposed to vibration or shock.
10. Clean the optical window using a soft cloth. Do not use organic solvent such as alcohol and thinner.
11. Perform a daily operation check, weekly periodical inspections, and prescribed maintenance procedures to ensure correct operation.
12. This product should be disposed of as an industrial waste.

3 PRECAUTIONS DURING USE

1. Be sure to route the sensor cables separate from any power transmission or high voltage line, or else use shielded cables. Using the same conduit or duct as high voltage or power lines will cause malfunctions or damage because of electromagnetic induction.
2. Do not apply excessive force to the cable.
3. When using a switching regulator, be sure to ground the frame ground (FG) terminal.
4. Turn off the power of the load first as this product may generate an output pulse when the power is turned off.
5. Avoid turning the power on and off consecutively.
6. When extending the cables, use conductors of 0.3 mm² cross-sectional area or more and check the voltage drop.
7. Limit the current of the power supply to 2A.
8. A malfunction may occur if foreign light including sunlight, inverter or LED light enters directly into the optical window of the sensor.
9. A glossy or mirror-like structure behind the detecting object may cause faulty operation. It may be fixed by mounting the sensor at an angle to the structure.

6 INDICATORS

- ① The operation indicator (orange LED) and stability indicator (green LED) show the levels of received light intensity as described in the figure.
- ② After distance setting, use a detection object to block and unblock the light beam several times to make sure that the both activation and deactivation are occurred within the stable light reception range and the stable light blocking range.
- ③ This setting achieves higher reliability against changes in the operating environment generated after installation.
- ④ The orange LED (OP.L) is the operation indicator. In the Light ON mode, it turns on when the sensor receives light. In the Dark ON mode, it turns on when the sensor receives no light.

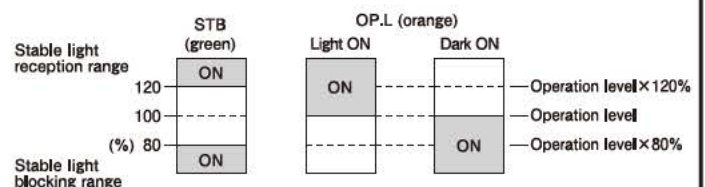

7 SETTING

Do not stop the selector in-between the two end stops. Do not apply excessive force to turn the selector over the end stop.

(1) Light ON/Dark ON

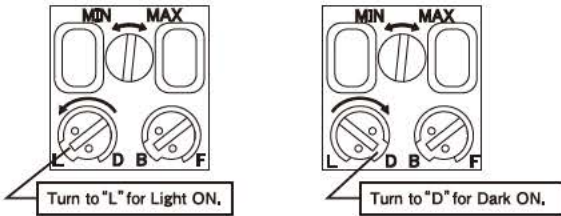

(2) BGS/FGS

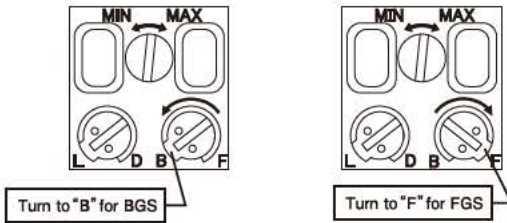

(BGS (Background Suppression))

BGS suppresses the effects from the background of the detection area.

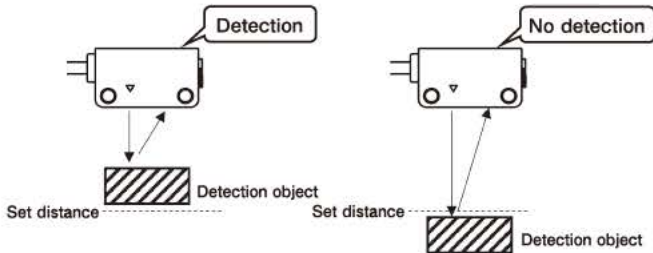

(FGS (Foreground Suppression: Background Recognition))

FGS recognizes the background and detects objects that are closer than the background. It is effective when there's a steady and detectable background such as belt conveyor. FGS detects objects of various sizes including black objects.

※ Install the sensor so that the background is located within the range of setting distance.

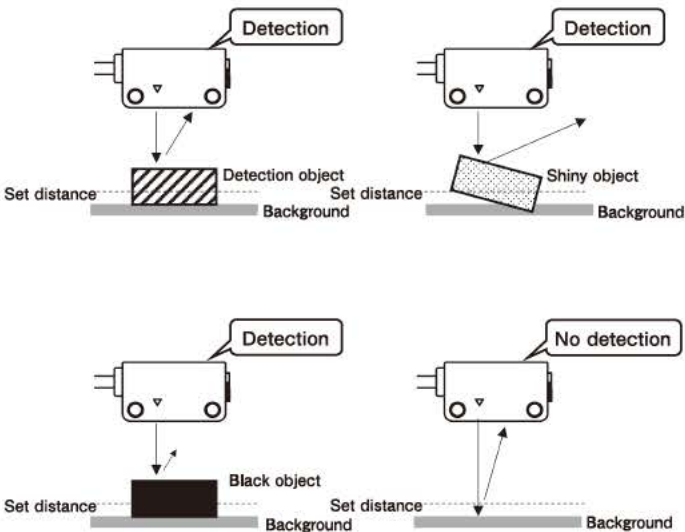

(3) Distance Setting

The distance settings for DLN-S10, DLN-S15, DLN-S20 and DLN-S30 are adjusted at factory to 100mm, 150mm, 200mm and 300mm respectively by using a white paper, at which the sensor has optimum sensitivity. The detection distance becomes longer than the specification when the distance setting volume is turned clockwise from the factory set position. The below shows the setting procedure for Light ON mode.

The LED operation becomes reversed for Dark ON mode.

(For BGS mode)

- Turn the distance setting volume counterclockwise until it clicks. (Five turns at the most.)

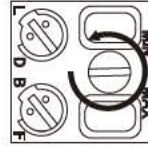

- Place a detecting object at the furthest point to be detected and turn the volume clockwise until the operation LED (orange) turns on (Point A). The detection distance may vary depending on the color, material or angle of the detection object.

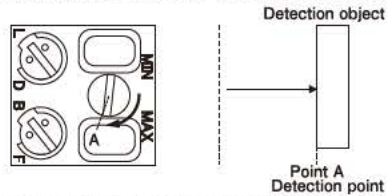

- When there is a background within the maximum detection range, remove the object and turn the volume clockwise and confirm the position where the sensor detects the background. (The operation LED turns on.)

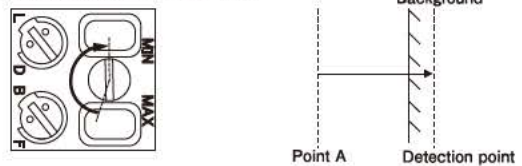

- Turn back the volume (counterclockwise) to the point where the operation LED turns off. (Point B)

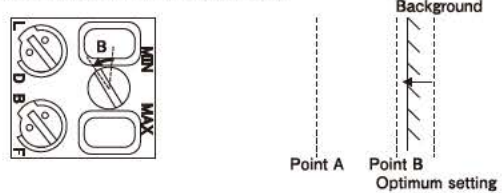

- Set the volume at the middle point between Point A and B.

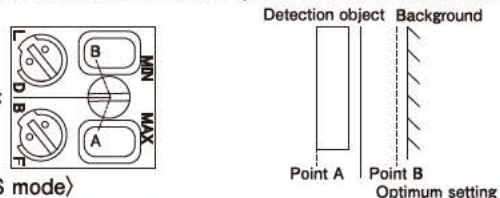

(For FGS mode)

- Turn the distance setting volume clockwise until it clicks. (Five turns at the most.)

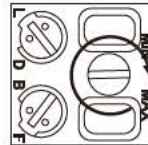

- Install the sensor at a detecting position so that the background is located within the range of detection distance. Confirm the operation LED turns ON, and then turn the distance setting volume counterclockwise until the operation LED turns off. Check the sensor doesn't detect the background under any conditions (ex. while the conveyor is moving).



8 DETECTING DIRECTION

Since the dual segment photo diode has directionality, the sensor may detect an object moving upward and downward even in the background outranged the setting distance.

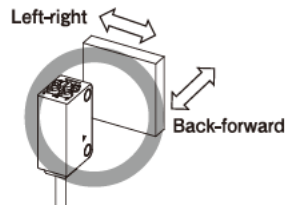

Within the set detection distance: Detection
Beyond the set detection distance: No detection

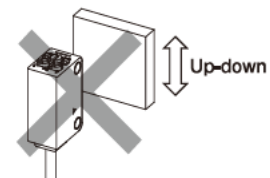

Within the set detection distance: Detection
Beyond the set detection distance: May detect

9 SPECIFICATION



Model	NPN model	DLN-S10RMV	DLN-S15RMV	DLN-S20RMV	DLN-S30RMV	DLN-S20MV	DLN-S10RMV-J	DLN-S15RMV-J	DLN-S20RMV-J	DLN-S30RMV-J
		DLN-S10RMV-Y5	DLN-S15RMV-Y5	DLN-S20RMV-Y5	DLN-S30RMV-Y5	————	DLN-S10RMV-J	DLN-S15RMV-J	DLN-S20RMV-J	DLN-S30RMV-J
	PNP model	DLN-S10RMVP	DLN-S15RMVP	DLN-S20RMVP	DLN-S30RMVP	————	DLN-S10RMVP-J	DLN-S15RMVP-J	DLN-S20RMVP-J	DLN-S30RMVP-J
Detection method		BGS/FGS (Background recognition)								
Detecting distance (※1)		10 to 100mm	10 to 150mm	10 to 200mm	20 to 300mm	10 to 200mm (at 90 to 200mm) 20 to 300mm (at 201 to 300mm)	10 to 100mm	10 to 150mm	10 to 200mm	20 to 300mm
Setting distance (※2)		90 to 100mm	100 to 150mm	150 to 200mm	100 to 300mm	90 to 300mm	90 to 100mm	100 to 150mm	150 to 200mm	100 to 300mm
Set distance at factory		100mm	150mm	200mm	300mm	200mm	100mm	150mm	200mm	300mm
Power supply		12 to 24VDC, class 2 / Ripple 10% or less								
Current consumption		18mA or less								
Operation mode		Light ON / Dark ON selectable (by switch)								
Output mode		NPN / PNP open collector 2 outputs NPN open collector output / Load current 100mA (30VDC, class 2) or less / Residual voltage : 1V or less PNP open collector output / Load current 100mA (30VDC, class 2) or less / Residual voltage : 2V or less								
Light source (wavelength)		Four-element (AlGaInp) LED (660nm)			Infrared LED (850nm)	Four-element (AlGaInp) LED (660nm)				
Response time		0.5 ms or less								
Hysteresis		5% or less								
Indicator		Operation indicator: orange LED Stability indicator: green LED								
Volume		Distance setting volume (5-turn endless potentiometer)								
Switch		BGS / FGS selector, Light ON / Dark ON selector								
Circuit protection		Output short circuit / Reverse connection / Surge protection								
Anti interference		Automatic mutual interference prevention function (※3)								
Material	Case	PBT								
	Lens	Polycarbonate								
Connection		Attached cable (outer diameter ϕ 4.0mm) 0.2mm ² × 4 cores 2m black 0.2mm ² × 4 cores 5m black (***-Y5)			Attached cable (outer diameter ϕ 4.0mm) 0.2mm ² × 4 cores 2m black		M8 4 pin connector (Cable with connector is separately available.)			
Weight		60g (2m cable), 135g (5m cable)			60g		12g			
Accessory		Instruction manual, screw driver (Mounting bracket: separately available)								

Note: The distance setting for DLN-S10, DLN-S15, DLN-S20 and DLN-S30 are adjusted at factory to 100mm, 150mm, 200mm and 300mm respectively by using a white paper, at which the sensor has optimum sensitivity.

※1 100mm × 100mm white drawing paper

※2 The detection distance becomes longer than the specification when the distance setting volume is turned clockwise from the factory set position.

※3 Check the operation when two sensors are installed adjacently. The mutual interference prevention function may not work properly depending on conditions of installation or detecting objects.

ENVIRONMENTAL SPECIFICATION

Ambient light	5,000 lx or less
Ambient temperature	-25 to +55°C
Storage temperature	-40 to +70°C (non-freezing/non-condensing)
Ambient humidity	35 to 85%RH (non-condensing)
Protective structure	IP 67
Vibration	10 to 55Hz double amplitude/1.5mm 2 hours each in 3 directions
Shock	500 m/s ² 3 times each in 3 directions
Dielectric withstanding	1,000 VAC 1 minute
Insulation resistance	500 VDC megger, 20M Ω or more

10 DIMENSIONS (in mm)

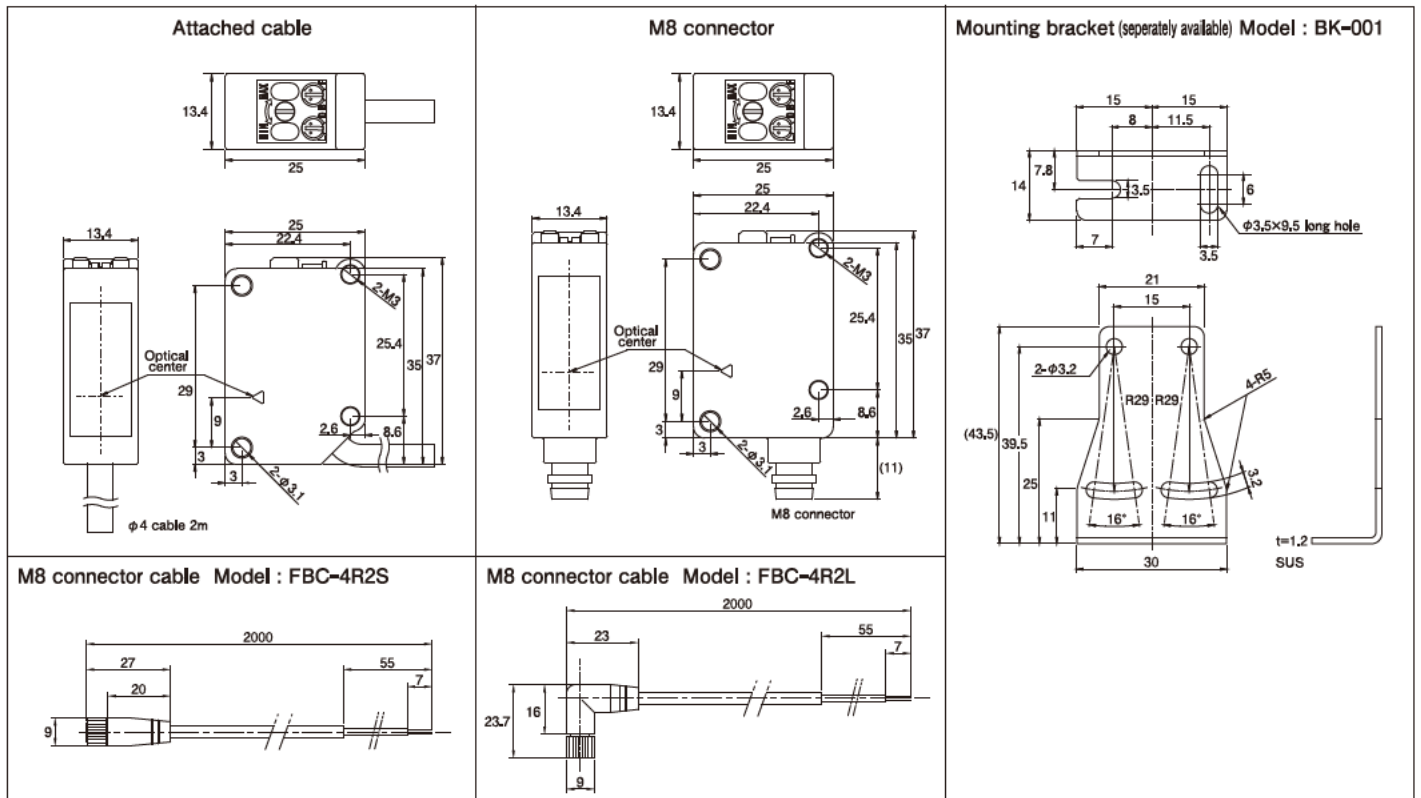

11 WARRANTY

The product is covered by a warranty based on the Quality Regulations of Takenaka Electronic Industrial Co., LTD. (Takenaka). Regarding the warranty, please feel free to ask any questions to Takenaka, Takex sales office or authorized distributors.

1 <Warranty period>

The warranty period is one (1) year after delivery to a designated location. This warranty does not apply to expendable supplies like batteries or relays, and products of other manufacturers which Takenaka markets.

2 <Scope of warranty>

If any defect is found during the warranty period. Takenaka will, at its option, repair or replace the defective product at the location of delivery. This warranty is void and of no effect if the product is subject to improper use or handling, improper maintenance, modification, repair made by persons not authorized by Takenaka or a lack of reasonable care. The warranty does not cover defects caused by the other product, reason including fire, flood, earthquake, lightning surge and other natural disasters.

- ① If the product is used inappropriately or used under inappropriate conditions that are not described in the instruction manual or specifications.
- ② If the defect is caused by improper maintenance, including a failure to replace consumable or periodical parts as described in the instruction manual or specifications.
- ③ If the defect is not directly caused by the warranted product.
- ④ If the products is modified or repaired by persons not authorized by Takenaka.
- ⑤ If the defect is caused by rough handling, dropping, or collision after the product is delivered.
- ⑥ If the defect could not be predicted from a technical viewpoint at the time Takenaka made the agreement for, manufactured, or installed the product.
- ⑦ If the defect is caused by a natural disaster such as a fire, flood, earthquake, lightning (including a lightning surge) and so on, or an accident such as an abnormal voltage that Takenaka is not responsible for.

The warranty provided here is only for the Takenaka product and does not cover any secondary damage caused by problems related to the product.

3 <Target of Warranty>

- (1) In case that the product is used in combination with other products or as a part of a system, Buyer should confirm the compatibility of the product to the application by relevant laws, decrees, standards and regulations.
- (2) This product is designed and manufactured for use in general industries. This warranty does not cover the application of the product to:
 - ① Nuclear power facilities including power station, incineration plant, public utilities including railway, vehicle and airway facilities, medical devices, amusement machines, safety devices and facilities that are governed by regulation of government or industrial organization.
 - ② Facilities that may cause danger or serious effects on human life and assets.
 - ③ Utilities like electricity, gas or water facilities. Facilities that are required 24 hour continuous operation.
 - ④ Outdoor use or use in improper conditions or environment.
 - ⑤ Other facilities which requires broad and detailed consideration concerning safety and reliability equivalent to the above.

This warranty may cover these application in case that Takenaka is notified about the application of the product before sale and Buyer approves the compatibility and the specifications of the product by written agreement and / or by providing r

12 DISCLAIMER

- This product is designed to detect a presence or passage of an object. This product does not have any function to prevent accidents, death or injuries. Takenaka will assume no responsibility for damages or losses resulting from accidents or disasters caused by a failure of the product, complete wiring or installation or any act that does not follow the instruction manual.
- Earthquakes, lightning (including lightning surges), fires that we are not responsible for, acts or incidents caused by third parties, intentional or accidental misuse, or usage under other abnormal conditions.
- Any secondary damage caused by the usage, faulty operation, or malfunction of the product like suspended operation or malfunction of a connected device or system, damage to a device, loss of profit, interruption of business, corruption or loss of memory contents, cost of restoration, etc.
- Misuse, failure related to maintenance, installation or deinstallation, or failure to follow the contents of the instruction manual.
- Any malfunction (including false alarm or lost alarm) caused by the combination with a connected device or software over that we have no control.
- The responsibility of Takenaka is limited to the extent of repair or replacement of the product. The expenses we are liable for will not exceed the original product cost.