

PRESENCE SENSOR MMW-3W(wide) / MMW-3S(spot)

Thank you very much for purchasing this product, please read this instruction manual to ensure correct operation. TAKEX is not responsible for damage, injury or losses caused by accident, theft, Acts of God (including inductive surge by lightning), abuse, misuse, abnormal usage, faulty installation or improper maintenance.

1 PRODUCT DESCRIPTION

MMW-3W / MMW-3S detects the finest movement of human or object with millimeter wave radar which is not affected by ambient light or temperature change. Can be mounted to either the wall or the ceiling with multi-pattern detection range adjustment.

2 PARTS DESCRIPTION

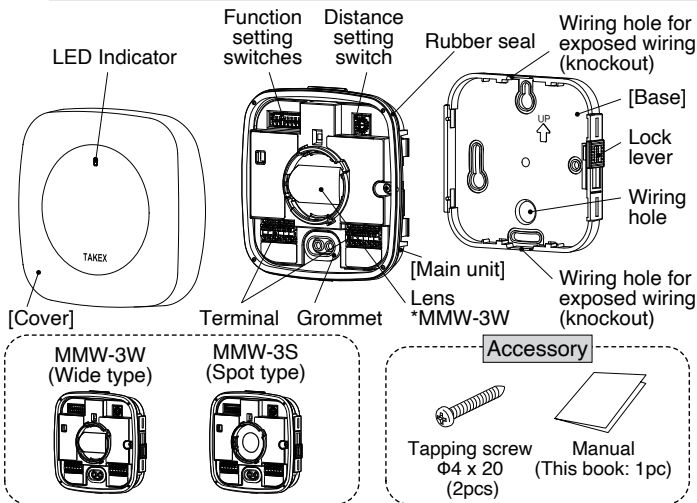

Detaching the cover

Hook your finger to bottom and remove the cover.



Area selectable

MMW-3W (wide type) can be switched detection area Horizontal / Vertical zone by rotating the lens 90 degrees. Rotate the lens to align ▲ mark as diagram below until click sound is made.

Horizontal area (Factory set)



Lens "Landscape"

Vertical area

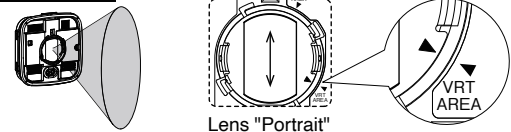

Lens "Portrait"

*Detection area is a sample. (Refer to 4 DETECTION AREA)
*MMW-3S (spot type) lens is fixed.

3 PRECAUTIONS Be sure to observe

• This manual describes precautions by classifying them based on degrees of danger and damage that would be generated when using the unit incorrectly.

Warning This indicates the possibility of severe injury, and even death, if ignored or a user handles the unit incorrectly.

Caution This indicates the possibility of minor injury and/or damage to properties, or of a notification delay in your system due to false operations and/or non-detection, if ignored or a user handles the unit incorrectly.

• These precautions are categorized throughout the manual using the following symbols.

A prohibited action, you must not do.

An action you must do, and information you should keep in mind.

Warning

- Do not disassemble or modify this device. Not only forbidden by the law, but also this may cause a fire, electrical shock, or malfunction of the device.
- Do not use in the environment includes flammable, explosive, or ignitable gases, or where dust is generated. This may cause a fire or explosion.
- Avoid using the device nearby the medical equipment not to give negative effects on them.
- Do not power that exceed the indicated power supply to the unit. Failure to follow this may result in fire, electric shock, and/or malfunction.
- Do not connect devices that exceed the indicated capacity to the output contact of the unit. Failure to follow this may result in fire, electric shock, and/or malfunction.

- Do not install the unit in a location that cannot support its weight.
- Make sure to install the unit to the solid wall/ceiling which has reinforcement. Secure the unit by using appropriate anchors and mounting screws depending on the material of the mounting surface.
- If the following events occur, turn off the power of the unit immediately, and ask the place of purchase for repair. Failure to follow this may result in fire, electric shock, and/or malfunction.
 - Smoke, abnormal odor, and/or sound are found
 - Liquid such as water and/or foreign body has entered the unit
 - The unit has deformed and/or damaged parts
- Do not touch terminals with wet hands. Failure to follow this may result in electric shock.

Caution

- Do not apply impact to the unit. It may cause performance degradation.
- Do not perform overhead wiring to avoid fire/electric shock.
- Do not use this device in the countries where FCC regulation does not support.

- Do not drop the device nor apply heavy load to the device.
- Make sure to seal unused holes such as wiring hole or knockout with caulking to prevent from water ingress.



Do not install the device on a location as following:

- Subject to water
- Steam sauna / mist sauna
- Exposed to direct sunlight
- Dusty



Make sure to check there is no foreign body (dust, sand, hair or liquid) at contact surface of the cover and the packing before attaching the cover. Clean it up with a clean cloth if there are some.



The unit may not operate properly near devices that generate a strong electric or magnetic field. Also, devices near the unit may not operate properly due to the electric and/or magnetic field generated from the unit. Make sure to confirm before operation.



- Avoid installing the device in a location as following:
- Moving objects in detection area (plants, laundry, fans or water)
 - Obstructing objects(including glass or transparent resin) in detection area (radio wave will be attenuated)
 - Reflective objects(metal, etc.) in detection area (may cause false alarms)
 - Having vibration

4 DETECTION AREA (Roughly illustrated)

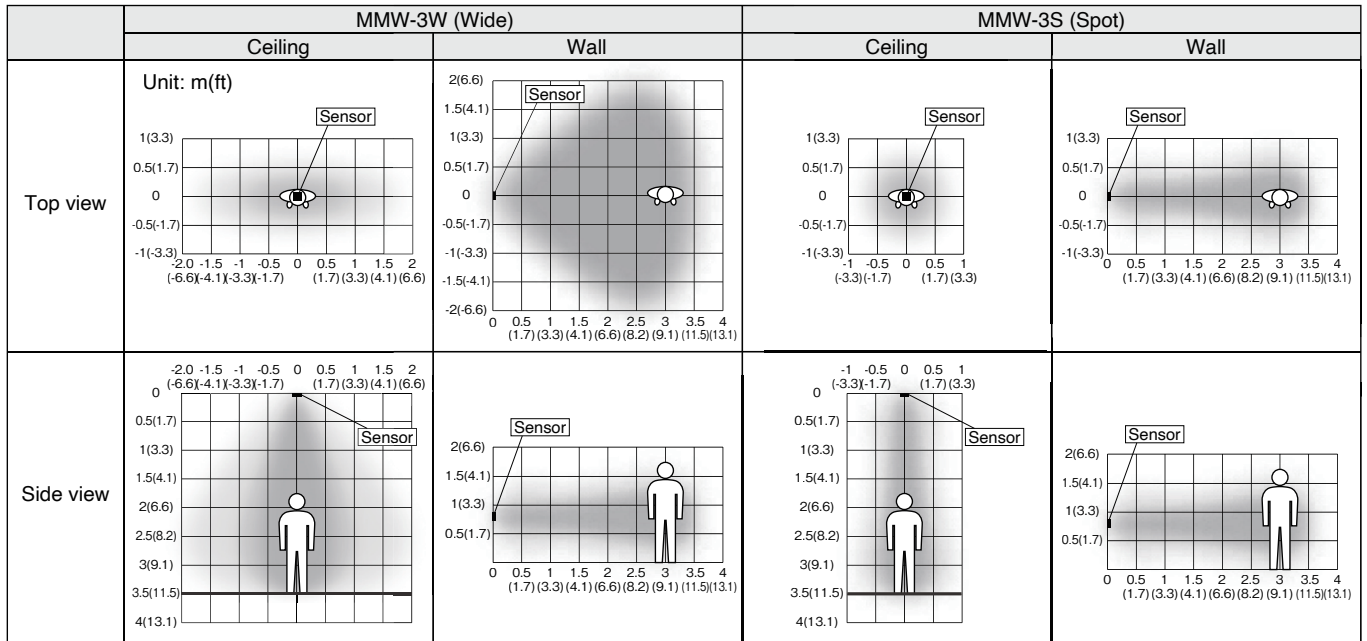

Note

*For MMW-3W (wide type), detection area is selectable for Horizontal / Vertical zone by rotating the lens 90 degrees.

*Unwanted detection may occur if there are objects that reflect radio wave such as metal materials in detection area.

*In case MMW-3W (wide type) is mounted to the ceiling, special note as below;

▶ The sensitivity is getting worse at the edge of the detection area because the amount of reflected radio wave is getting fewer.

▶ Reflective objects such as metal may cause false detection even if it is located outside of the detection area.

*In case multiple sensors are installed facing each other, make sure to avoid detection zones overlap and to adjust detection distance so that they do not interfere with one another.

5 INSTALLATION

• For Ceiling/Wall mount (Diagram below is for wall mount)

- Hook your finger to bottom and remove the cover.

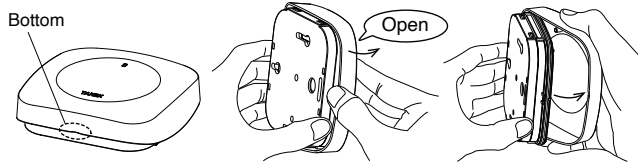

- Slide the lock lever until click sound is made and remove the main unit from the base.

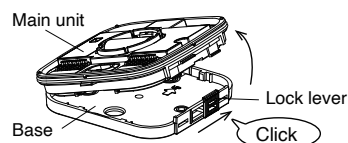

- Pull in the wiring through the wiring hole and install the base to mounting surface with attached 2pcs x tapping screws (Φ4 x 20).

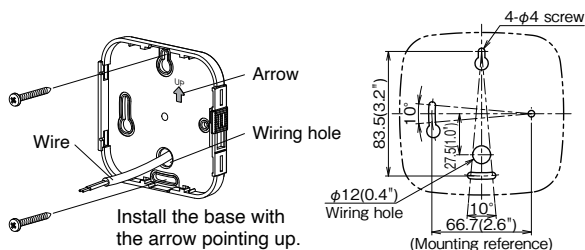

- For exposed wiring, break through the knockout on the base and do wiring as following diagram. (Refer to **6 WIRING**)

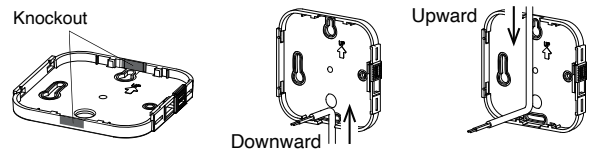

- Make a hole with a screw driver from the back side of the grommet. Apply caulking for insect invasion protection.

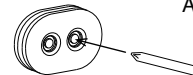

- Pull in the wiring through the grommet, attach the main unit to the base, and slide the lock lever to secure the main unit until click sound is made. After connecting wiring to the terminals, attach the cover to the main unit until click sound is made. Make sure that the wiring is not interfering to the cover.

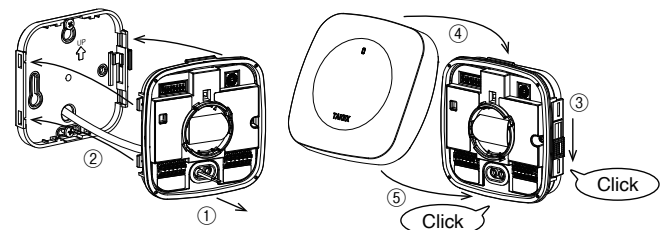

6 WIRING

Wiring connections

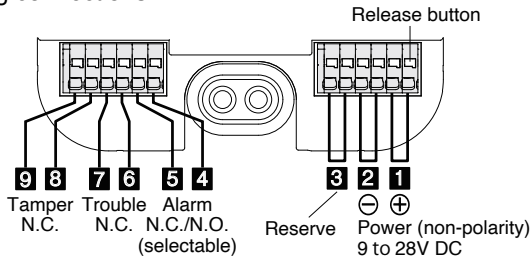

- Terminal 1 2 3 have internal continuity for interconnected wiring.
- Terminal 1 is the screwless type. Push the release button when pulling out the wiring from the terminal.

1 Power ⊕	9 to 28V DC 40mA or less (non-polarity)
2 Power ⊖	
3 Reserve	For interconnected wiring
4 5 Alarm	Contact : Dry contact N.C. / N.O. selectable Operation : Continuous output during detection *at least 2sec. Capacity : 30V (DC/AC) 0.2A (resistive load)
6 7 Trouble	Contact : Dry contact N.C. Operation : Output at low voltage or sensor failure Capacity : 30V (DC/AC) 0.2A (resistive load)
8 9 Tamper	Contact : Dry contact N.C. Operation : Output at the cover removed Capacity : 30V (DC/AC) 0.1A (resistive load)

Standard wiring

(Multi-units connected in the same line)
*Detection output (N.C.)

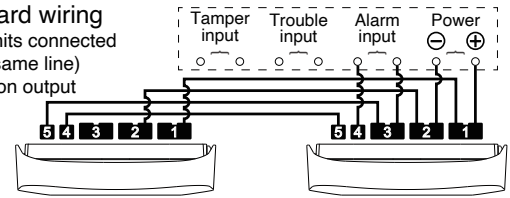

Recommended wire

Solid wire : $\phi 0.65\text{mm}$ 1.2mm Stripping length : 8mm
0.2mm² to 1.0mm²
AWG24 AWG16



Make sure to use the wire $\phi 6\text{mm}$ or less if the wire pulled into the unit through broken knockout of the base for exposed wiring. Otherwise, $\phi 6\text{mm}$ or more wiring will interfere with the main unit. Or, peel the sheath beforehand the knockout. For insect invasion protection, apply caulking as needed.

Wiring distance

Solid wire

Wire size	Voltage	12V DC	24V DC
$\phi 0.65\text{mm}$		350m (1,150')	1,800m (6,000')
$\phi 0.9\text{mm}$		650m (2,150')	3,400m (11,100')
$\phi 1.2\text{mm}$		1,200m (4,000')	6,100m (20,000')

*When 2 or more units are connected, the wiring distance is calculated as follows: [Above / number of units]

7 FUNCTIONS

Function setting switches

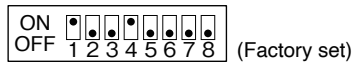

1. LED indicator

ON : Always ON
OFF : Always OFF
(Red blinking at Trouble output)

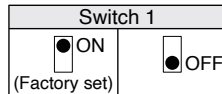

2. Memory indicator

ON : Blink 3min. at detection (yellow) and turning to light 47min. and turning off. LED lighting time is retriggered by extra detection.
OFF : Memory OFF

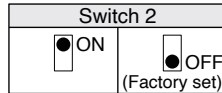

3. Detection output

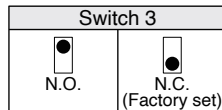

4. Sensitivity

Set "Low" if false alarms frequently occur.

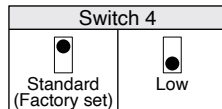

5. Mounting location

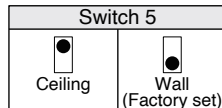

6. Buzzer

ON : Sound during detection
OFF : Buzzer OFF

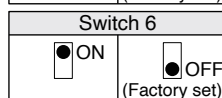

7-8. On-delay

In case setting at other than "None", signal is output if the sensor continuously detect the target over preset on-delay timer. Once the sensor missed the target, the detection timer is reset.

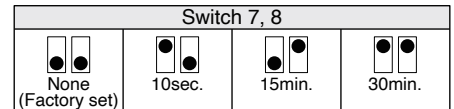

Distance setting switch

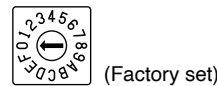

Setting	Distance(m)
0	0.2
1	0.3
2	0.4
3	0.6
4	0.8
5	1.0
6	1.25
7	1.5
8	1.75
9	2.0
A	2.25
B	2.5
C	2.75
D	3.0
E	3.25
F	3.5

Detection distance

Detection distance can be set at 16 patterns. Select distance depending on the application/installation environment.

Tamper

Monitoring the cover condition and informing the act of removing the cover. The sensor initiates tamper output as the cover detached and/or incomplete installation performed. Recovery when the cover is installed properly. Make sure to check the sensor condition and perform operation check once tamper output confirmed.

8 OPERATION CHECK

- Make sure to perform a sufficient operation check on the whole system before operation.

Perform operation check by checking LED indicator with the cover attached in the actual installation position.

- LED(blue) turns on 1sec. at powered to the sensor, and LED(blue) keeps lighting if there is no detection object in detection area. LED(red) turns on at detection. *Buzzer "beep" is activated during detection if the buzzer setting is ON.
- Check if alarm output is initiated by standing in the detection area. Output operation check must be done both the sensor(indicator) side and the controller side.
- Remove the cover and confirm the tamper output operation. Tamper output stops as the cover attached.
- Put the system into the operation after checked all items above. (Lastly, select LED indicator ON/OFF, Buzzer ON/OFF as needed.)

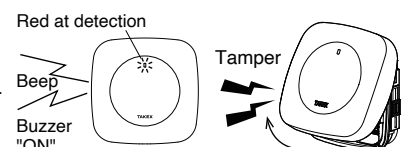

9 TROUBLESHOOTING

Check the sensor by referring to the table below. If you cannot restore the sensor to normal condition after the check, contact the dealer of purchase or TAKEEX.

Trouble	Cause	Action
Completely inactive	(1) No power supply (broken or improper wiring) or low voltage	(1) Correct wiring or adjust power voltage
Non-detection	(1) Inappropriate installation location (2) Inappropriate detection distance setting	(1) Relocate the sensor (2) Adjust the detection distance setting
Connected equipment inactive even though LED & Buzzer works	(1) Alarm signal connection failure or broken/shorted wiring	(1) Fix connection failure or broken/shorted wiring
Activate without human presence	(1) Unstable power voltage (2) Moving objects in detection area (3) Inappropriate installation location (4) Inappropriate detection distance setting (5) Unstable installation	(1) Correct power voltage (2) Remove / Keep away moving objects from detection area Set detection sensitivity "Low" (3) Relocate the sensor (4) Adjust the detection distance setting (5) Install the sensor securely

- Maintenance**
- To clean the device, use a soft and wet cloth and then wipe off any water drops. Do not use substances such as thinner or benzene. (The plastic parts may be deformed, discolored or deteriorated.)
 - Perform operation check once a week in regular basis.

10 SPECIFICATION

Description	Presence sensor	
Model	MMW-3W/(BK)	MMW-3S/(BK)
Area	Wide	Spot
Supply voltage	9 to 28V DC (non-polarity)	
Current consumption	40mA max.	
Frequency	60GHz	
Detection distance	3.5m (11.5 ft) max. (16 patterns)	
Alarm output	Contact : Dry contact N.C./N.O. selectable Operation : Continuous output during detection *at least 2sec. Capacity : 30V (DC/AC) 0.2A (resistive load)	
Trouble output	Contact : Dry contact N.C. Operation : Output at low voltage or malfunction Capacity : 30V (DC/AC) 0.2A (resistive load)	
Tamper output	Contact : Dry contact N.C. Operation : Output at the cover removed Capacity : 30V (DC/AC) 0.1A (resistive load)	
LED operation	Powered : Blue lighting (1sec.) Standby : Blue lighting Detection : Red lighting Trouble : Red blinking Memory : Yellow blinking(3min.), lighting(47min.), automatically OFF	
On-delay timer	4 patterns (none, 10sec, 15min, 30min)	
Functions	LED Indicator, Memory LED ON/OFF, Sensitivity, On-delay, Installation environment, Buzzer, Distance setting, Tamper	
Mounting	Indoor : Ceiling / Wall	
Ambient temperature	-25°C to +50°C (-13°F to +122°F) without condensation	
Connection	Screwless terminal	
Weight	160g (5.6oz)	
Appearance	Resin (cover : white / black(BK), main unit : gray)	

Specifications and design are subjected to change without prior notice.

11 EXTERNAL DIMENSIONS (Unit: mm)

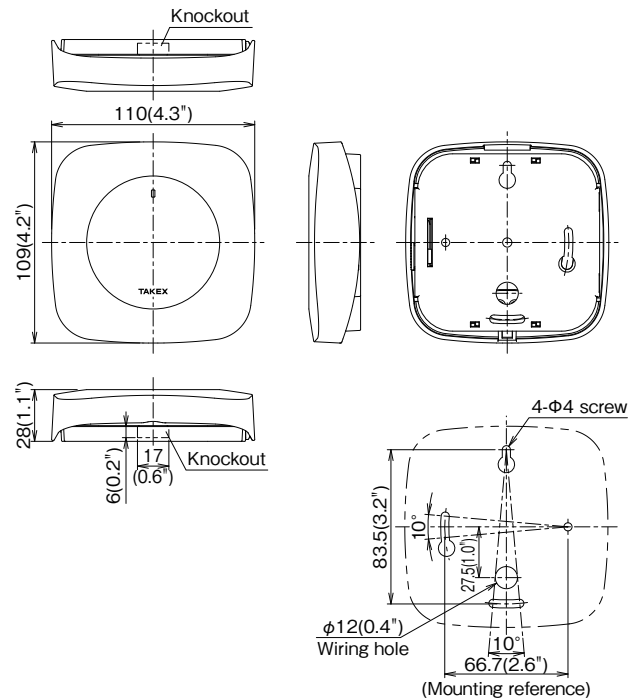

- Option:
Ceiling/Wall attachment BCW-401/(BL)

12 SPECIAL NOTE

FCC

- (1) FCC Regulation Statement: This equipment has been tested and found to comply with the limits for a Class B digital device, pursuant to part 15 of the FCC Rules. These limits are designed to provide reasonable protection against harmful interference in a residential installation. This equipment generates, uses and can radiate radio frequency energy and, if not installed and used in accordance with the instructions, may cause harmful interference to radio communications. However, there is no guarantee that interference will not occur in a particular installation. If this equipment does cause harmful interference to radio or television reception, which can be determined by turning the equipment off and on, the user is encouraged to try to correct the interference by one or more of the following measures: -Reorient or relocate the receiving antenna. -Increase the separation between the equipment and receiver. -Connect the equipment into an outlet on a circuit different from that to which the receiver is connected. -Consult the dealer or an experienced radio/TV technician for help.

WARNING : Changes or modifications not expressly approved by the party responsible for compliance could void the user's authority to operate the equipment.

- (2) RF Exposure Warning Statement : This equipment complies with FCC radiation exposure limits set forth for an uncontrolled environment. End users must follow the specific operating instructions for satisfying RF exposure compliance. This transmitter must be at least 20 cm from the user and must not be co-located or operating in conjunction with any other antenna or transmitter. The information in this guide may change without notice. The manufacturer assumes no responsibility for any errors that may appear in this guide.

Limited Warranty :

TAKEEX products are warranted to be free from defects in material and workmanship for 12 months from original date of shipment. Our warranty does not cover damage or failure caused by Acts of God (including inductive surge by lightning), abuse, misuse, abnormal usage, faulty installation, improper maintenance or any repairs other than those provided by TAKEEX. All implied warranties with respect to TAKEEX, including implied warranties for merchantability and implied warranties for fitness, are limited in duration to 12 months from original date of shipment. During the Warranty Period, TAKEEX will repair or replace, at its sole option, free of charge, any defective parts returned prepaid. Please provide the model number of the products, original date of shipment and nature of difficulty being experienced. There will be charges rendered for product repairs made after our Warranty period has expired.



TAKENAKA ENGINEERING CO., LTD.

In Japan

Takenaka Engineering Co., Ltd.
83-1, Gojo-Dori, Sotokan Nishi-iru, Higashino,
Yamashina-ku, Kyoto 607-8156, Japan
Tel : 81-75-501-6651
<https://www.takeex-eng.co.jp/>

In the U.S.

Takeex America Inc.
1810 Oakland Rd, Suite F,
San Jose, CA 95131, USA
Tel : 408-747-0100
<https://www.takeex.com>

In Australia

Takeex America Inc.
4/15 Howleys Road, Notting Hill,
VIC, 3168
Tel : +61 (03) 9544-2477
<https://www.takeex.com>

In the U.K.

Takeex Europe Ltd.
Aviary Court, Wade Road,
Basingstoke, Hampshire. RG24 8PE, U.K.
Tel : (+44) 01256-475555
<https://www.takeex.com>