

TAKEX PASSIVE INFRARED SENSOR

PA-480S

Instruction Manual

Thank you for purchasing this product. Before using the products, please read this instruction manual carefully to ensure correct operation.

1 PRODUCT DESCRIPTION

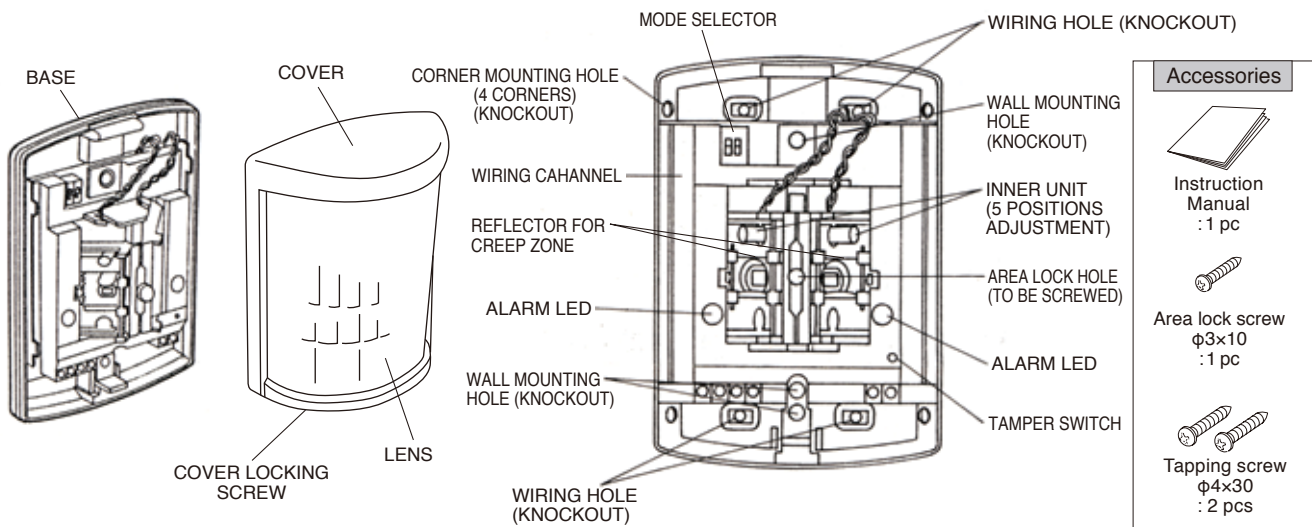

2 PRECAUTIONS

Be sure to observe

This manual describes precautions by classifying them based on degrees of danger and damage that would be generated if using the unit incorrectly.

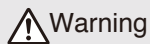

Warning

This indicates the possibility of severe injury, and even death, if ignored or a user handles the unit incorrectly.



Caution

This indicates the possibility of minor injury and/or damage to properties, or of a notification delay in your system due to false operations and/or non-detection, if ignored or a user handles the unit incorrectly.

We categorize these precautions throughout the manual using the following symbols.



A prohibited action, you must not do.



An action you must do, and information you should keep in mind.

Warning



Do not disassemble or modify this device. This may cause a fire, electrical shock, or malfunction of the device.



If the following events occur, turn off the power of the unit immediately, and ask the place of purchase for repair. Failure to follow this may result in fire, electric shock, and/or malfunction.

- Smoke, abnormal odor, and/or sound are found
- Liquid, such as water, and/or foreign material has entered the unit
- The unit has deformed and/or damaged parts



Do not install this device in a location that cannot support its weight. This may lead the device to fall and cause an injury or malfunction of the device.



Mount the unit on solid ceilings or wall surfaces where reinforcement materials are used. If you mount the unit on non-wood materials such as plaster board or concrete, securely mount it using anchors and mounting screws that match the wall materials. Unstable mounting may result in injury and/or property damage if the unit falls.



Do not use the unit with power voltage levels other than those specified. Failure to follow this may result in fire, electric shock, and/or malfunction.



Do not connect devices that exceed the indicated capacity to the output contact of the unit. Failure to follow this may result in electric shock, fire, and/or malfunction.



Do not touch terminals with wet hands. Failure to follow this may result in electric shock.

Caution



Do not apply impact to the unit. Strong impact may result in performance deterioration and/or damage to the unit.



The unit may not operate properly near devices that generate a strong electric or magnetic field. Also, devices near the unit may not operate properly due to the magnetic field and/or magnetism generated from the unit. Make sure to confirm before operation.



Make sure to perform a sufficient operation check on the whole system before operation.



Refer to the detection area chart, and select the installation location. Then, check the actual operation, and adjust the appropriate area.



Make sure to check operation when you move tables and partitions to change the layout in protected rooms.



Do not install the unit in places subject to oil, smoke, steam, high humidity, and/or a lot of dust. Electricity that is conducted through these substances may result in fire, electric shock, and/or false operation.

⚠ Caution

- ❗ Avoid installing the unit in the following places. Otherwise, non-detection and/or false detection may occur.
 - Places subject to strong direct or reflected light (sunlight, spotlight)
 - Places subject to rapid temperature fluctuations (air outlets of air-conditioning equipment, etc.)
 - Places where moving objects are included in the protection area (plants, laundry, etc.)
 - Places subject to strong vibration and/or electric noise
 - Places where pets, such as dogs and cats, and/or automatic cleaning robots may pass
 - Places where shielding objects (including glass and transparent resin, etc.) are placed in the protection area (shading parts will not be detected)
 - Places that people can easily touch.

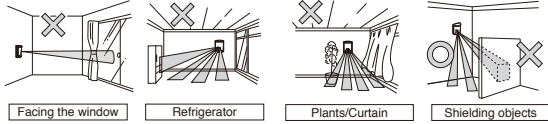

- ❗ Passive infrared sensors are designed to detect changes of far-infrared ray energy. Energy changes largely when the human body moves across the detection area. However, energy does not change so much when the human body comes closer in a straight line, or stops. In addition, if the environment of detection area generates similar changes due to certain factors, the unit will issue an alarm without being able to judge properly.

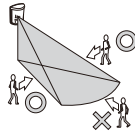

- ❗ Ask qualified personnel for any electrical work necessary for installation, if required. Failure to follow this may result in fire and/or electric shock.
- ❗ Securely conduct installation work according to the instruction manual. Also, make sure to use the supplied accessories and specified components. Failure to follow this may result in injury and/or property damage in the event of fire, electric shock or fall of the unit.
- ❗ This unit is for indoor use. Do not use the unit in places subject to water and/or high humidity. Failure to follow this may result in malfunction if water gets into the unit.
- ❗ This unit is not a waterproof (moisture proof/rainproof) or dust-proof structure. Do not use the unit in places subject to water and/or high humidity, such as bathrooms, and/or subject to large amounts of dust or sand. Failure to follow this could result in malfunction.
- ⊘ Do not perform aerial wiring of power and signal cables. Failure to follow this may result in electric shock, fire, and/or malfunction.
- ⊘ Do not install the sensor directly on the ceiling (When installed on ceiling, use optional attachment BCW-401)

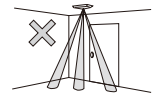

3 DETECTION AREA

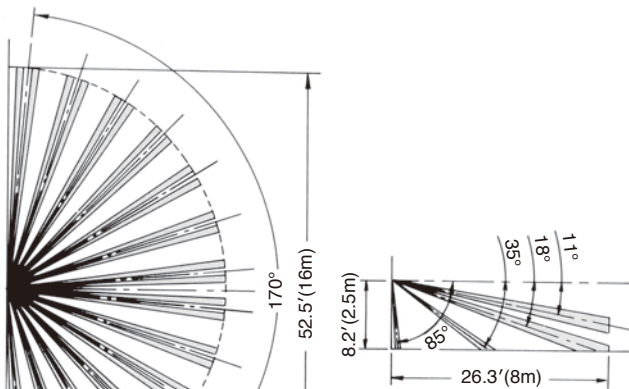

WALL MOUNT APPLICATION

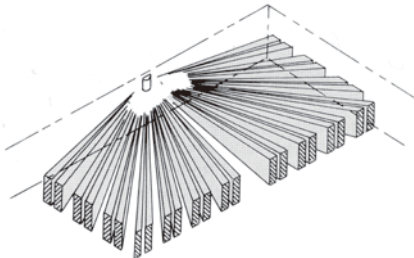

PILLAR MOUNT APPLICATION (2 units)

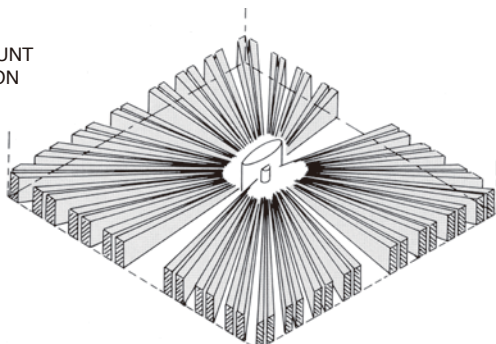

AREA ADJUSTMENT

The area of protection is adjusted to allow for different mounting heights. By moving the inner unit upwards, the coverage of the sensor is decreased.

- The area can be adjusted independently 90° each side to side
- Hole the inner unit to move.
- Check operation whenever the protected area is changed.

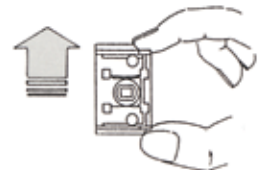

AREA LOCK

After adjustment, lock the inner unit with the provided area lock screw.

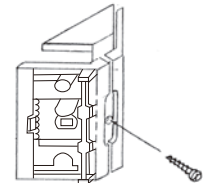

ADJUSTMENT DIAGRAMS

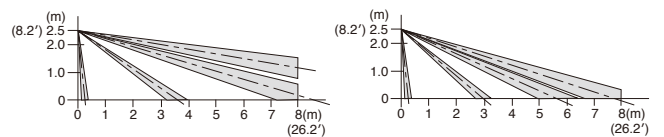

NORMAL (FACTORY SETTING POSITION)

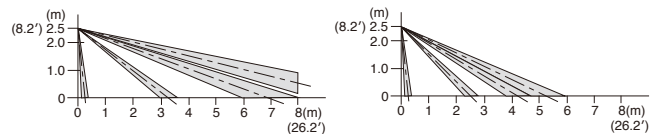
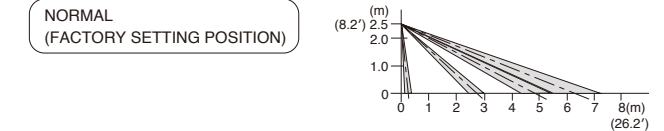

Different coverage by 90° each



4 INSTALLATION

1. Loosen the cover locking screw and remove the cover. Do not remove the screw from the cover not to lose locking nut.

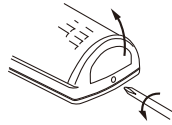

2. For wall mounting, use wall mounting hole located in the center of the base. For corner mounting, break 4 knockouts on both side to use corner mounting holes.

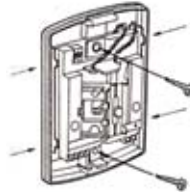

3. Break knockouts of wiring holes required to connect wires. In case wiring through upper wiring holes, pass the wires along wiring channels on either side of the base to connect them to the terminal.



4. Attach the cover and tighten the cover locking screw.



5 WIRING

Terminal Arrangement

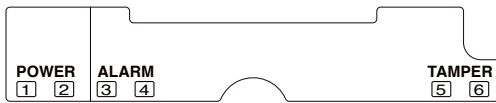

1 2

POWER
(non-polarity)
9.5V to 28V DC
20mA Max.

3 4

ALARM OUTPUT
Dry contact N.C. (semi-conductor)
Reset : approx. 2 sec.
30V DC (24V AC) 0.25A Max.
(Protective resistor 3.3Ω)

5 6

TAMPER OUTPUT
Dry contact N.C.
Operation : Open when cover is detached.
30V DC 0.1A Max.
(Protective resistor 3.3Ω)

Basic connection

[When two units are used]

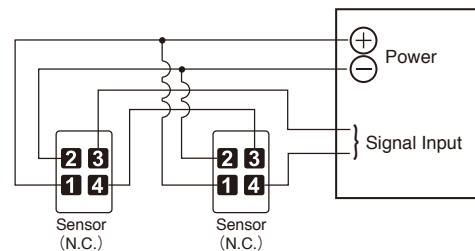

WIRING DISTANCE BETWEEN SENSOR AND POWER SOURCE

Size of wire used	Distance at 12VDC	Distance at 24VDC
AWG 20 (Dia.0.8mm)	4,600ft (1,400m)	27,500ft (8,400m)
AWG 18 (Dia.1.0mm)	7,200ft (2,200m)	43,000ft (13,200m)
AWG 17 (Dia.1.1mm)	8,900ft (2,700m)	51,000ft (15,500m)

Note : 1) Maximum wiring distance, when two or more sets are connected, is the value above divided by numbers of sets.

2) The signal line can be wired to a distance of 3,280 ft (1,000m) with AWG 22 (0.65mm dia.) wire.

* Allow approx. one minute for warm-up after power is supplied. (Alarm LED is flashing) In the meantime, no alarm is initiated.

* After the one minute has passed, the unit will be in the armed status and will trigger an alarm when detecting a human body.

6 FUNCTION

MODE SELECTOR

Sensor operation can be adjusted to fit the environmental conditions / applications with the built-in mode selector.

ALARM LED

The alarm LED will light up, synchronized with the alarm contact, if you set the mode selector at ON.

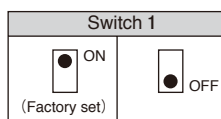

SIGNAL COUNT

The number of counts can be selected according to environmental conditions.

4 : Less sensitivity; prevents false alarms caused by temperature fluctuation.

2 : Normally set to this position.

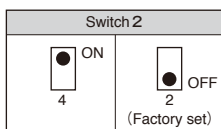

FACTORY SET

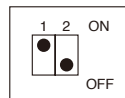

TROUBLE ALARM

This function checks / monitors sensor unit itself in accordance with built-in program.

When trouble is found out as a result of the check / monitor, alarm LED lights and an alarm signal also continuously outputs.

1 : Unit trouble

Trouble alarm outputs when inner circuit / wiring is damaged / broken. See "8. TROUBLESHOOTING" and remedy table.

NOTE : The monitor functions regardless of mode settings but an alarm is not indicated in case of setting alarm LED at OFF position.

When power is reset during the alarm status, trouble alarm stops only for warming up time.

2 : Low voltage

When power voltage of sensor drops down (approx. 8.5V DC or less), trouble alarm outputs before sensor operation becomes unstable due to low voltage. See "8. TROUBLE-SHOOTING" .

NOTE : The monitor functions regardless of mode settings but an alarm is not indicated in case of setting alarm LED at OFF position.

When power voltage recovers to normal level during the alarm status, trouble alarm stops.

7 OPERATION CHECK

When installation is completed, turn the power "ON" and check operation after about 1min. warming up time, as follows:

1. Make sure that alarm LED finished flickering.
2. Make a walk test in the protected area to check if an alarm is initiated. Check alarm LED and control panel for sensor operation.
3. After correct operation has been confirmed, use the mode selector switch to disable the alarm LED, if required.

8 TROUBLESHOOTING

Analyze possible problems according to the following table. If normal operations cannot be restored by these means, contact either the dealer from whom you bought the unit or TAKEX.

Trouble	Check	Corrective Action
Completely inactive	(1) Power supply is not connected (including broken wiring). (2) Power supply voltage is low. (3) 1 minute has not passed yet since turning the power ON. (4) The detection area is blocked by obstacles (which may include glass). (5) Improper detection (including detection distance). (6) Improper function mode setting.	(1) Check the power wiring. (2) Supply appropriate power voltage. (3) Wait approximately 1 minute. (4) Remove obstacles. (5) Readjust detection area. (6) Readjust mode setting.
Sometimes inactive	(1) Improper detection area settings (including detection distance). (2) Improper function mode setting. (3) Detection lens is covered with dust or water droplets.	(1) Readjust detection area. (2) Readjust mode setting. (3) Clean the lens with soft and dry cloth.
Activated when no person has passed	(1) Unstable power supply voltage. (2) Something is moving within the detection area, or there are sudden changes in temperature. (3) A source of electrical noise (broadcasting station, amateur radio station, etc.) is nearby. (4) Strong light (direct or reflected) such as sunlight or headlights from front side of the detection area. (5) Detecting someone passing outside the detection area. (6) There are many charges in temperature in detection area. (7) Movement of pets is detected. (8) Movement of robot cleaners is detected.	(1) Supply appropriate power voltage. (2) Remove problem object. (3) Change mounting location. (4) Change mounting location or shield light with blinds, etc. (5) Readjust detection area. (6) Set signal count to "4". (7) Prevent pets from entering detection area. (8) Prevent robot cleaners from entering detection area.
Alarm LED lights, but connected devices are inactive	(1) Wiring failure, broken wire, or short-circuit. (2) Connected devices don't function normally.	(1) Connect wiring correctly, or repair problem wire. (2) Check connected devices.
Alarm LED continues lighting and alarm output doesn't stop. (Abnormal detection)	(1) Unstable power supply voltage.	(1) Supply appropriate power voltage.

MAINTENANCE

- To clean the device, use a soft, wet cloth and then wipe off any water drops. If the device is particularly dirty, dip the soft cloth in the water that contains a weak neutral detergent. Wipe the device gently with the cloth, then wipe off any detergent that remains. Do not use substances such as thinner or benzene. (The plastic parts may deform, discolor or change their properties.)
- Perform operation checks on a regular basis.

9 SPECIFICATIONS

Model	PA-480S
Detection System	Passive infrared (Twin element · Pulse count)
Coverage	Super Wide angle radius 26.3' (8m)
Sensitive zone	64 (32pairs)
Area adjustment	Downward 5 positions
Supply Voltage	9.5 to 28V DC (non-polarity)
Current consumption	20mA Max.
Alarm output	Dry contact N.C. (Semi-conductor) Reset : Apporox, 2 sec. 30V DC (24V AC) 0.25A Max. (protective resistor 3.3Ω)
Tamper output	Dry contact N.C. Open when cover is detached 30V DC 0.1A MAX. (protective resistor 3.3Ω)
LED(Red)	Alarm LED Flickering (every 0.5 sec.) : Warning-up Lighting (approx. 2 sec.) : Alarm Flickering (every 2 sec.) : Trouble indication Continuous lighting : Trouble alarm
Trouble signal	Unit trouble : Monitoring inner circuit and wiring damage • Operation : Trouble alarm Low voltage trouble : Monitoring low voltage • Operation : Trouble alarm
Ambient temperature range	+14°F to +122°F (without dewdrops) (-10°C to +50°C)
Mounting position	Indoor (Wall/pillar) Ceiling mount is possible with optional attachment
Wiring connections	Terminals
Weight	5.82oz (165g)
Appearance	resin (White)

※Specifications and design are subject to change without prior notice.

10 EXTERNAL DIMENSIONS

Unit: inch (mm)

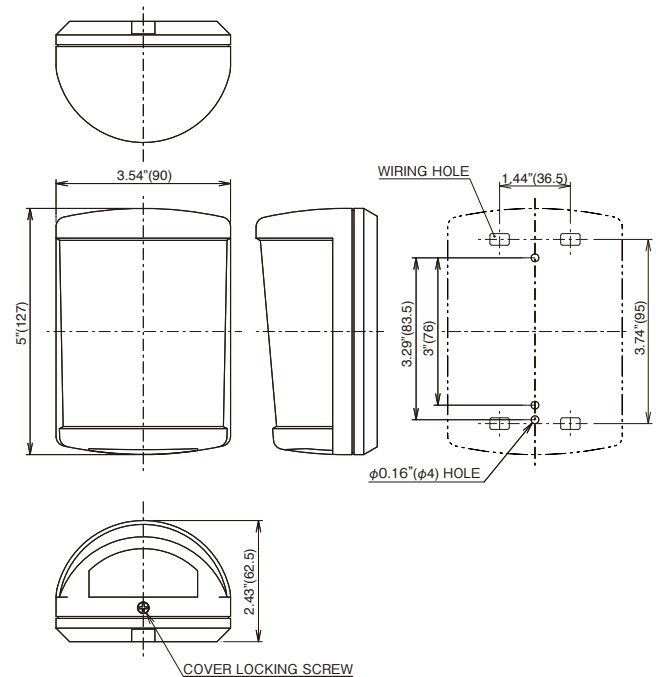

■Option : Ceiling/Wall mounting attachment : BCW-401

Limited Warranty :

TAKEX products are warranted to be free from defects in material and workmanship for 12 months from original date of shipment. Our warranty does not cover damage or failure caused by natural disasters, abuse, misuse, abnormal usage, faulty installation, improper maintenance or any repairs other than those provided by TAKEX. All implied warranties with respect to TAKEX, including implied warranties for merchantability and implied warranties for fitness, are limited in duration to 12 months from original date of shipment. During the Warranty Period, TAKEX will repair or replace, at its sole option, free of charge, any defective parts returned prepaid. Please provide the model number of the products, original date of shipment and nature of difficulty being experienced. There will be charges rendered for product repairs made after our Warranty Period has expired.

TAKEX TAKENAKA ENGINEERING CO., LTD.

In Japan
Takenaka Engineering Co., Ltd.
 83-1, Gojo-sotokan,
 Higashino, Yamashina-ku,
 Kyoto 607-8156, Japan
 Tel : 81-75-501-6651
 Fax : 81-75-593-3816
<http://www.takex-eng.co.jp/>

In the U.S.
Takex America Inc.
 3350, Montgomery Drive,
 Santa Clara,
 CA 95054, U.S.A
 Tel : 408-747-0100
 Fax : 408-734-1100
<http://www.takex.com>

In Australia
Takex America Inc.
 4/15 Howleys Road, Notting Hill,
 VIC, 3168
 Tel : +61 (03) 9544-2477
 Fax : +61 (03) 9543-2342

In the U.K.
Takex Europe Ltd.
 Takex House, Aviary Court, Wade Road,
 Basingstoke, Hampshire. RG24 8PE, U.K.
 Tel : (+44) 01256-475555
 Fax : (+44) 01256-466268
<http://www.takexeurope.com>