

TAKEX PHOTOELECTRIC BEAM SENSOR [ANTI-CRAWL]

PB-100AT-KH : OUTDOOR 100m (330 ft.)

Instruction Manual

Thank you for purchasing our "intelligent" quad photoelectric beam.
 This unit will provide long term, dependable service when properly installed.
 Please read this Instruction Manual carefully for correct and effective use.
 This product is a photoelectric beam sensor designed to be installed in a beam tower (sold separately).
 The beam tower to be used is recommended to be rated IP 55 or more.

Please Note : This sensor is designed to detect intrusion and to initiate an alarm ; it is not a burglary or a crime preventing device.
 TAKEX is not responsible for damage, injury or losses caused by accident, theft, Acts of God (including inductive surge by lightning), abuse, misuse, abnormal usage, faulty installation or improper maintenance.

[FEATURE]

The PB-100AT-KH beam is equipped with many features which provide a wide choice of field selectable options. These options result in considerable flexibility for a variety of application requirements.

● Anti-crawling

PB-100AT-KH is designed to prevent a crawling intrusion to protection distance by means of OR-gated detection in addition to AND-gated detection.

● Dual response time system

Two individual response times are provided for separate adjustment of AND/OR gates.
 This enables detection of intruders with minimum false alarms.

(AND-gated : Set at faster response time)
 (OR-gated : Set at slower response time)

● High power infrared

The active infrared transmission is exceptionally strong with a maximum arrival distance ten times greater than the specified protection distance.

● Four channel frequency selection

4 separate choices of frequency avoids cross-talk.

● Beam transmission strength selection

2 levels of beam transmission strength which can be set to suit the protection distance.

● Auto-gain lock

Optimal sensitivity gain is automatically set at any protection distance up to the maximum protection distance. (Audible tone indicates setting is completed.)

● Environmental module

Environmental trouble signal is sent when beam reception level is reduced below an acceptable level.

● Programmed AGC function

Sensitivity is automatically increased in bad weather to contend with fog, rain, or frost.

● Audible signal for alignment

An alignment tone aids in quick set-up of beams for electrical measurement of alignment.

● Other features

Monitor output, Beam selector

[BASIC OPERATION DESCRIPTION]

This anti-crawl sensor was developed for high security applications to detect a crawling intrusion and are based on our PB-IN-HFA series quad photoelectric beam sensors.

(Basic system)

Transmitters project separate double pulse modulated beams of different pulse pattern.
 Receivers only respond to the individual transmitted beam.

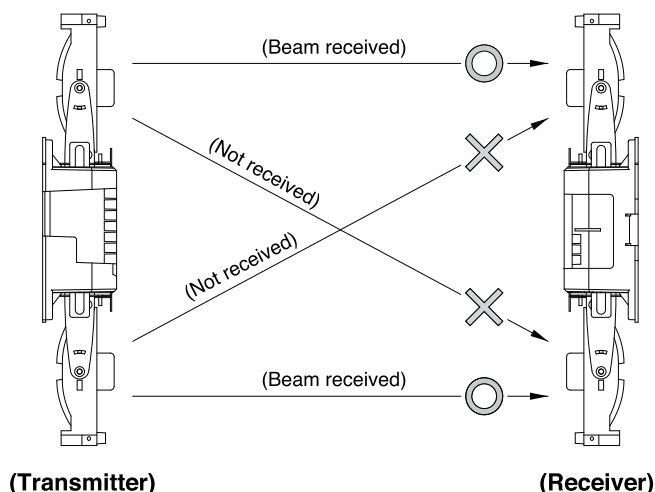

(Basic operation)

The following basic operation is required to detect a crawling intrusion and minimize false alarms.

Individual beam detection : An alarm is not initiated by instantaneous beam interruption, but an alarm is initiated when the interruption continues during a set response time. [OR gated]
 The response time should be set at a time which will detect crawling intrusion and minimize false alarm risk due to small animals.

All beam detection : An alarm is initiated when both sets of beams are interrupted during a set response time. [AND gated]

- 1) Response timeSeparately adjustable for AND-gated or OR-gated on receiver unit.
- 2) 4 channel frequency selection is available. : See 6.1 Four channel frequency selection.

1 PARTS DESCRIPTION

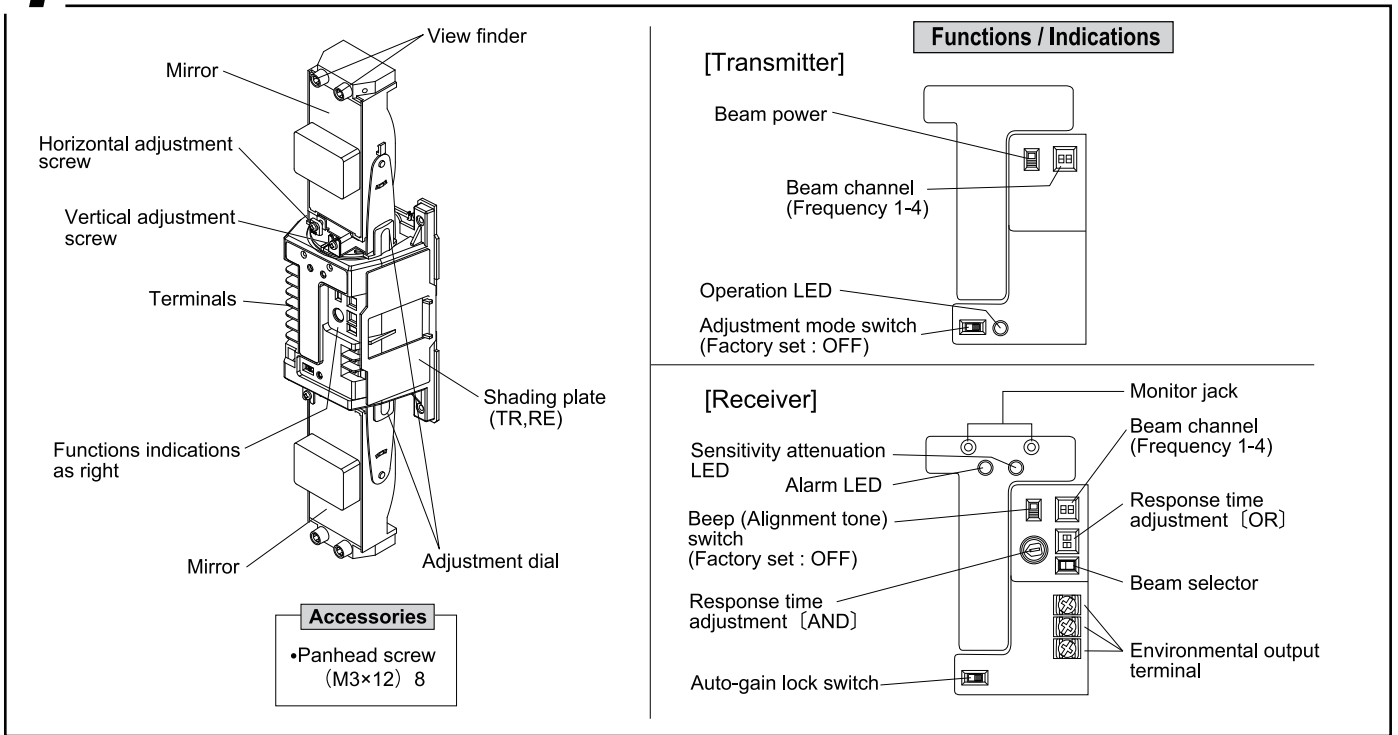

2 PRECAUTIONS

• This manual describes the precautions to be observed for safe operation of this device by classifying them into the following categories. As these are important, be sure to read and strictly observe them.

Description of the Display

- Warning** Indicates information that if ignored and the device is handled incorrectly, may result in death or serious injury.
- Caution** Indicates information that if ignored and the device is handled incorrectly, may result in injury or damage to property.
- This symbol indicates a prohibited action, with the specific action shown near the symbol. **Example:** Do not disassemble
- Indicates useful information.

Warning

- Do not use the sensors powered with a voltage level other than the indicated power supply voltage specified (between 12 to 30V DC). Doing so may cause a fire or electrical shock.
- Do not connect a device that exceeds the capacity shown to the output contact of this device. Doing so may cause a fire or electrical shock.
- Do not touch the terminal section with wet hands. Doing so may cause an electrical shock.
- Do not disassemble or modify this device. Doing so may cause a fire, electrical shock, or malfunction of the device.
- If smoke or an abnormal odor or sound is found, leaving it unattended may cause a fire or electrical shock. Immediately turn off the power to the device and confirm that the abnormal state has been corrected, and then ask the place of purchase for repair.

Caution

- Do not install this device in a location that cannot support its weight. Doing so may cause the device to fall and cause an injury or malfunction of the device.

EXAMPLE OF INCORRECT INSTALLATION

DON'TS Do not install as shown below. This will cause erroneous detection or detection failure .

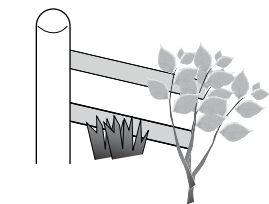

- Installation in locations shaded by trees etc.

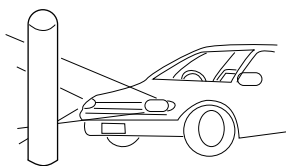

- Installation in location where strong light such as sunlight or light from vehicle headlights can directly enter the receiver

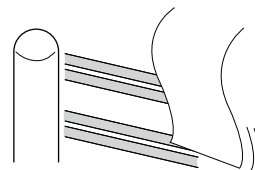

- Installation in areas where objects that move with the wind (the laundry etc.) can obstruct the optical axis

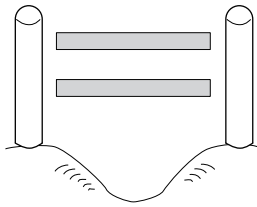

● Installation on uneven ground

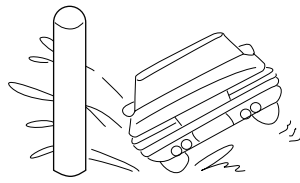

● Installation in locations where the unit may be splashed by dirty water or direct sea spray

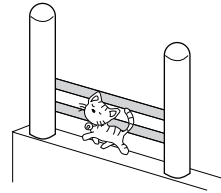

● Installation directly above a wall

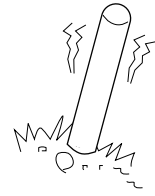

● Installation in an unstable, wobbling location

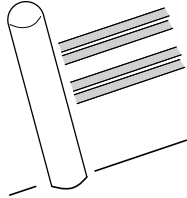

● Slanted installation

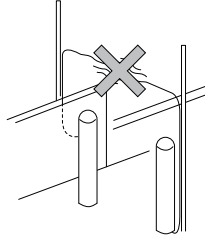

● Overhead wiring

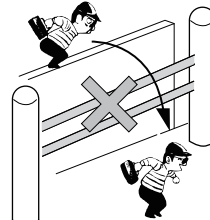

● Installation close to a wall



Other than PB-100AT-KH
PB-100HFA-KH
PB-100AT-KH

● Using PB-100AT-KH/100HFA-KH together with other beam sensors or different protection distance beam sensors in stacking



Cautions when using the outdoor photoelectric beam sensor (Daily maintenance)

- In areas where there are trees or weeds, the infrared may get obstructed by overgrown branches or leaves. As this may cause erroneous detection, be sure to trim down leaves and branches according to the growth of the plants. Furthermore, the infrared may get obstructed by swaying branches or leaves due to wind. Keep in mind the swaying of leaves and branches when trimming them.
- Vine type plants may wrap around the photoelectric beam sensors causing erroneous detections. Therefore, be sure to prune such plants regularly.
- Other natural phenomena such as insects or bird droppings may soil the sensors causing miss detection. Be sure to clean the sensors regularly.

3 INSTALLATION

In order to use these sensors correctly, thoroughly read this instruction manual and select the mounting position and protection distance.

1. Protection distance

Position the sensor with consideration to installation site, installation height and protection distance for effective use.

Installation height and protection distance

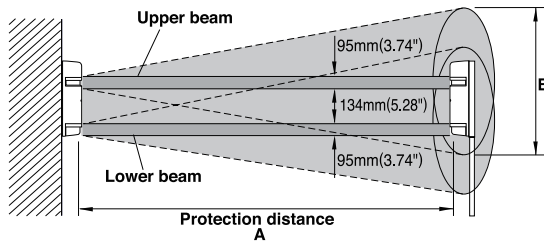

● Take into consideration the beam spread to avoid potential reflection from ground surface or nearby objects.

A	B
100m (330') or less	2.4m (8')

2. Wiring

Connecting power to both transmitter and receiver wiring differs depending on number of sensors or number of zones.

Wire size also differs depending on distance between sensor and control panel / power source.

Wiring should be completed in accordance with NFPA-70 of the National Electrical Code. (U.S. ONLY)

The equipment must be powered from an LPS in accordance with EN60950-1 : 2006+A2 : 2013

1) Basic connection

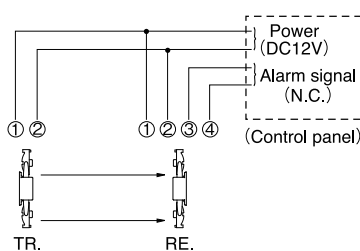

2) When two or more sensors are connected to the same line

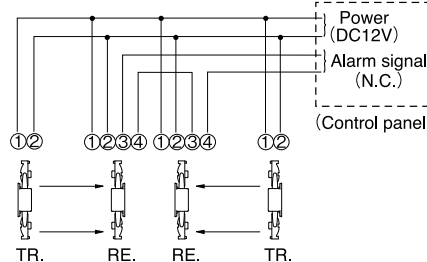

3) When two or more sensors are connected to separate lines

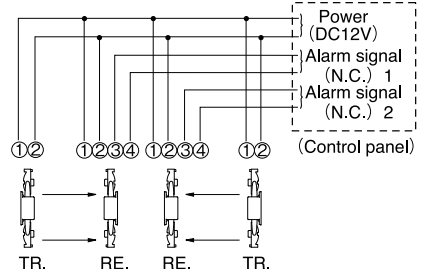

4) Double stacked standard connection

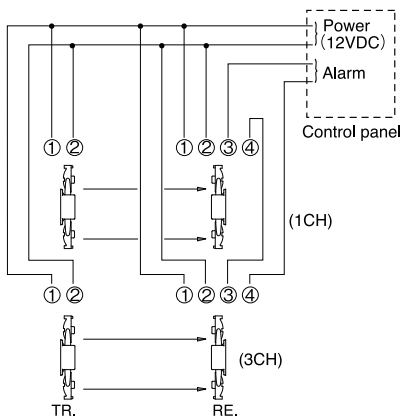

Note) Refer to 5. FUNCTIONS DESCRIPTION for beam channel (beam frequency selection).

6) Wiring Distance between sensor and control panel

wire size	voltage	12V DC	24V DC
AWG20 (Dia.0.8mm)		192m (630')	1340m (4400')
AWG18 (Dia.1.0mm)		300m (1000')	2100m (6900')
AWG17 (Dia.1.1mm)		366m (1200')	2560m (8400')
AWG16 (Dia.1.25mm)		473m (1550')	3200m (10500')
AWG15 (Dia.1.4mm)		595m (1950')	4000m (13500')
AWG14 (Dia.1.6mm)		777m (2550')	5340m (17500')

Note 1)

Max. wiring distance when two or more sets are connected is the above value divided by the number of sets.

Note 2)

The signal line can be wired to a distance up to approx. 1000m (3300') with Dia. 0.65mm (AWG 22) telephone wire.

5) When environmental module is used

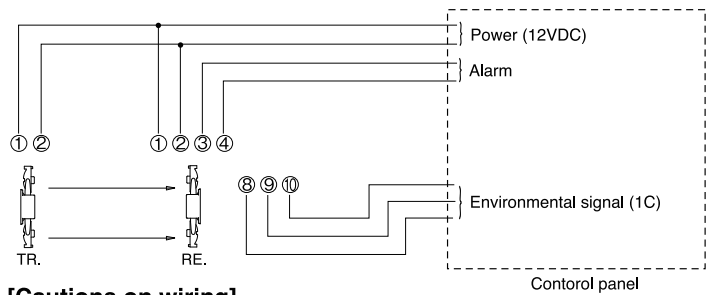

[Cautions on wiring]

- Signal output on receiver can not be used independently for the upper / lower optics, only as a set.
- Outdoor wiring should be in PVC if below ground or use direct burial cable. Conduit should be used for above ground wiring.

*Standby battery

Be sure the control panel is equipped with adequate standby battery and charging circuit. Use 12V (at least) NiCd or lead acid battery with minimum capacity of 0.5AH.

—Estimated battery life—

No. of pair	Md AA 0.5AH	Gel Cell 1.0AH	Gel Cell 5.0AH
1	5 hr	11 hr	58 hr
2	—	5 hr	29 hr
4	—	—	14 hr
8	—	—	7 hr

- Unit should be connected to a listed, class 2 power source capable of providing standby power for a minimum of 4 hours.

3. Terminal arrangement

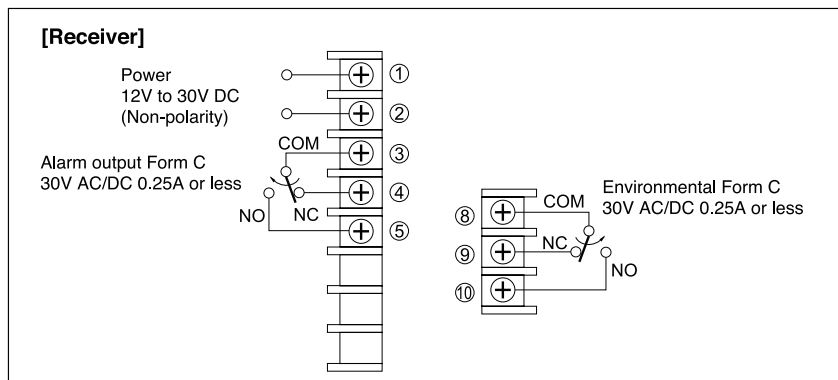
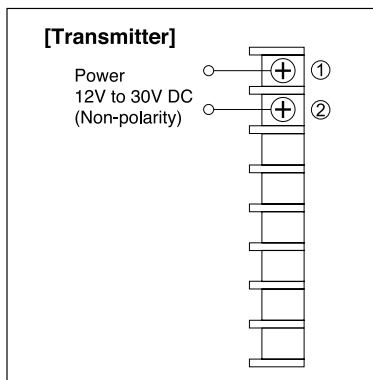

4. Mounting

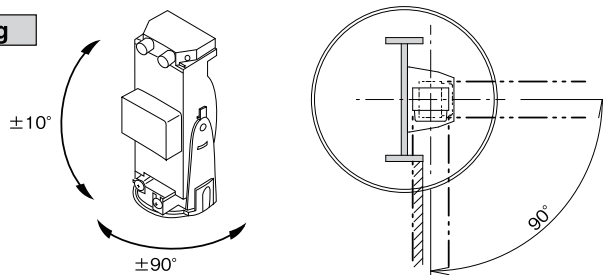

- The mirror unit can be moved by using the adjustment screw horizontally (± 90 degrees) and vertically (± 10 degrees) allowing the unit to work in all directions.
- Install the unit to a beam tower. Some towers could block the beam within its case when the mirror is turned by $\pm 90^\circ$ vertically. Please refer to the instruction manual of the beam tower carefully before use.

4 SET-UP OF FUNCTIONS AND BEAM ALIGNMENT

- 1) Supply power with cover off.
- 2) Set function options.
(Refer to 6. FUNCTIONS DESCRIPTION for detailed explanation of each option.)
- 3) Set the Auto-gain lock switch to "ADJ" in receiver

Location	Functions	Function Switches
TR/ RE	Beam channel (frequency)	<input type="checkbox"/> 1 CH. <input type="checkbox"/> 2 CH. <input type="checkbox"/> 3 CH. <input type="checkbox"/> 4 CH.
TR. only	Beam power	<input type="checkbox"/> H <input type="checkbox"/> L
RE. only	'Beep' alignment tone	<input type="checkbox"/> ON <input type="checkbox"/> OFF
	Beam selector	<input type="checkbox"/> Upper <input type="checkbox"/> Lower
	Response time adjustment	A N D O R <input type="checkbox"/> 0.035sec. (standard) <input type="checkbox"/> 0.5sec. (MAX.) <input type="checkbox"/> 0.1sec. <input type="checkbox"/> 0.2sec. <input type="checkbox"/> 0.3sec. <input type="checkbox"/> 0.5sec.

4) Adjust optical angle.

- 1) Look through view finder on either side of the upper optical unit in transmitter and move until receiver unit is visible.
- 2) Repeat the procedure for lower optical unit, and then repeat on receiver.

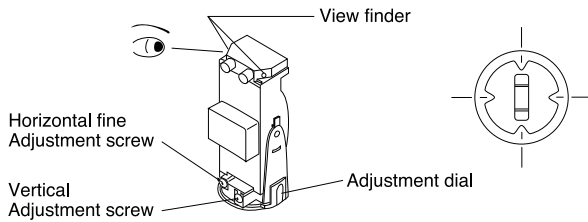

5) Fine tuning

Initial beam alignment can be achieved by using the alignment tone indicator.

- 1) Set the beam selector to UPPER in RE.
- 2) Set the adjustment mode switch to ADJ in TR.
- 3) Attached the shading plate (stored on side of TR., RE.) to the lower optic of TR, RE.
- 4) Turn the beep switch to ON in RE.
- 5) Adjust the optics with the adjustment screws until highest tone is reached. (Note : There will be no sound if the attenuation LED is lit.)
- 6) Set the beam selector to LOWER.
- 7) Reverse the procedure and repeat adjustment.
- 8) Turn the alignment tone switch to OFF.

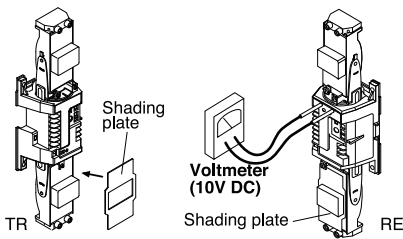

After initial beam alignment is completed, definitive alignment is achieved by using a voltmeter.

- 9) Set the beam selector to LOWER in RE.
- 10) Attach the shading plate to the upper optic of RE.
- 11) Insert leads from voltmeter in monitor jacks of RE.
- 12) Check the voltage for the lower optics of RE.

Readings for alignment are as follows.

Alignment	Voltage reading [With checker]
Best	1.8V or more
Good	1.4 to 1.8V
Poor, Re-adjust	1.4V or less

* When monitor output is 1.4V or less, adjust beam alignment again.

- 13) Reverse the procedure and check the voltage for the upper optics of RE.
- 14) After adjustment, replace the shading plates in the storage areas of TR, RE.
- 15) Place the covers on the beam line. Set the Adjustment mode switch to OP in TR. and set the Auto-gain lock switch to ON in RE.
- 16) 5sec. after, sensitivity margin will be automatically set and gain lock will be completed after beep sound is heard once.

If the beep sound is heard in an intermittent way, sensitivity is not good.

In this case, set the Adjustment mode switch to ADJ, the Auto-gain lock switch back to "OFF" again, and adjust beam alignment again.

(Please refer to 6.3 Auto-gain lock function.)

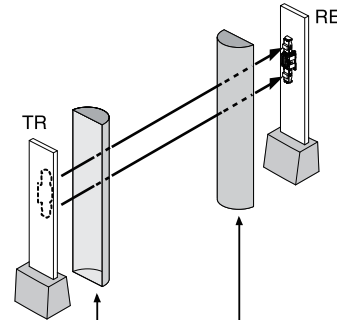

Place the covers on the beam line to complete the setting of the Auto-gain lock function so as to get the same beam strength as the covers are attached.

5 OPERATION CHECK

- 1) Alarm LED only.
- 2) Alarm LED and beep tone. (Walk test mode)
Set the beep switch to "ON", then a beep tone will be issued upon beam blockage for five minutes after the Auto gain is locked.

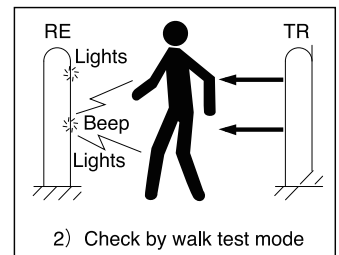
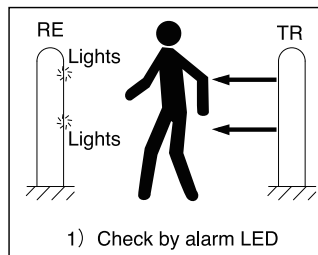

6 FUNCTIONS DESCRIPTION

1. Four channel frequency selection

The combination of 1CH and 3CH or 2CH and 4CH (do not use adjacent channels) are recommended to avoid crosstalk between units which are stacked, in-line, or other configurations which have the potential of spill-over transmission from one beam to another. Set the frequency level as illustrated.

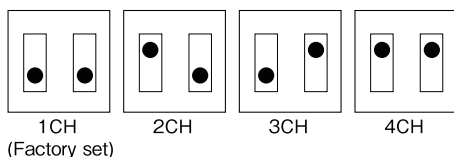

MAKE SURE TRANSMITTER AND RECEIVER OF PAIR ARE SET AT SAME CHANNEL ! Paired TR/RE will not set up unless set at the same channel.

1) Linear protection

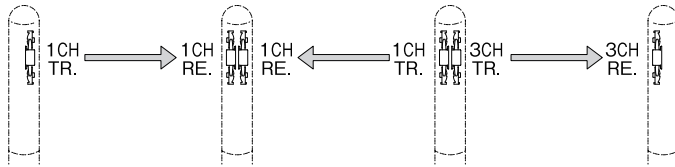

2) Double stacked protection

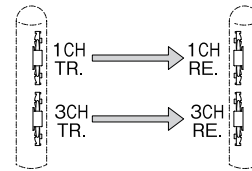

3) Double stacked linear protection

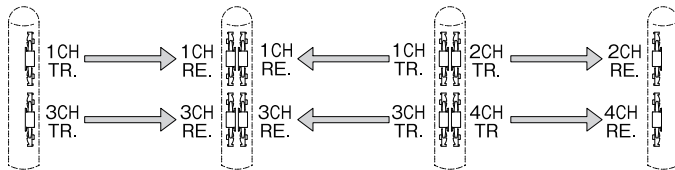

4) Perimeter protection

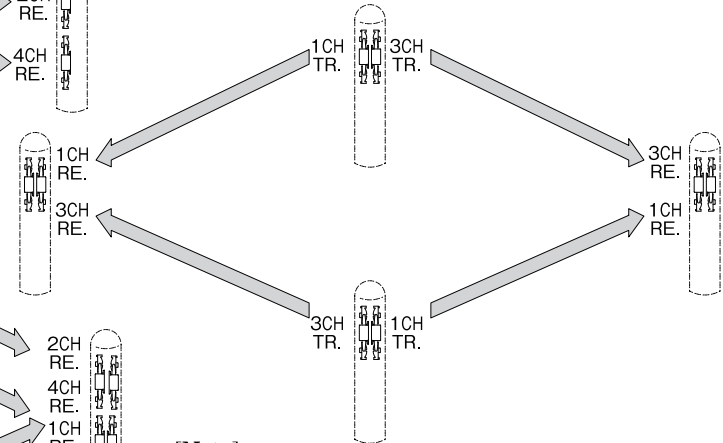

5) Double stacked perimeter protection

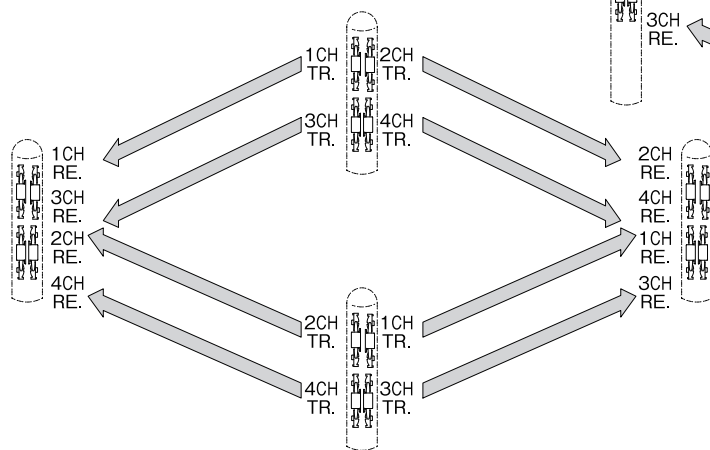

[Note]

- The use of a voltmeter for alignment is advised to ensure highest level of stability.
- Consult with TAKEX distributor or TAKEX regional office about the frequency selection for installations not mentioned in this instruction manual. Inappropriate choice of frequency may cause malfunction.
- Always use PB-100HFA-KH in combination with PB-100AT-KH when stacked installed (same directional transmission). The other models may cause malfunction.

2. Beam power selection

This option allows field selection of the appropriate beam intensity relative to the application. For distance significantly less than the specified protection distance, the beam intensity should be reduced to eliminate potential reflection problems. For zones reaching maximum protection distance, the beam level should be set to the highest level.

Note : For interior applications where greater chance for reflection occurs, the setting should be at LOW.

- H (Factory set)
- L

H	Over 75m (250') to 100m (330')
L	75m (250') or less

3. Auto-gain lock function

- 1) The auto-gain lock serves to standardize the responsiveness and tolerance level of the units regardless of varying distance in an installation.

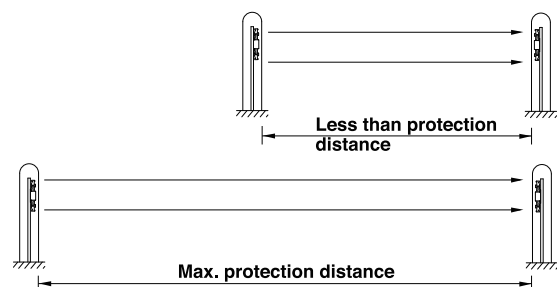

The situations above have exactly the same tolerance and responsiveness levels even though the distance is different.

- 2) A "beep" tone is issued from the receiver approximately 5 seconds after set the Auto-gain lock switch to ON in receiver. This tone indicates the Auto-gain has been set. Refer to the chart below.

Tone	Indicates	Result	Cause	Remedy
One pulse (Beep)	Optimal sensitivity has been set.	OK	_____	_____
Continuous tone (20 seconds)	Optimal sensitivity can not be set.	NG	1. Beam is interrupted when set the Auto-gain lock to ON in receiver. 2. Beams are mis-aligned and sensitivity attenuation LED lights.	1. Remove any blockage items or ensure hand is not breaking beam and set the Auto-gain lock switch to ON in receiver again. 2. Check beam power setting at transmitter with cover off and re-adjust beam alignment.

Note 1) A tone is generated regardless of whether "beep" (alignment tone) switch is set to ON or OFF.

2) The auto-gain setting is locked in for approximately two weeks even if power is disrupted.

4. Tone indicator

This feature provides audible testing or signals for the following items.

Test / Signal	Beep switch	Other condition	Description
Beam alignment	ON	<ul style="list-style-type: none"> Adjustment mode switch to ADJ. Auto gain lock switch to OFF. 	<ul style="list-style-type: none"> Reception strength monitored. Tone pitch increases as reception improves. (Note : No tone is given if sensitivity attenuation LED is lit or if receiver cover is attached.)
Walk test	ON	For approx. 5 min. after gain is locked.	<ul style="list-style-type: none"> Tone is linked to alarm LED. Both trip simultaneously.
Auto-gain lock	ON or OFF	<ul style="list-style-type: none"> About 5sec. after the Adjustment mode switch to OP. Auto gain lock switch to ON. 	<ul style="list-style-type: none"> Short tone indicates lock is set. Continuous tone (20sec.) indicates readjustment.

5. Response time changeover function (Dual response time system)

And-gated response time and OR-gated response time can be set separately.

- 1) An object passing through the beams faster than the set response time is undetected.
- 2) Adjust response time a little slower where the units may be affected by many birds.

Note) Set AND-gated response time shorter (faster) than OR-gated response time.

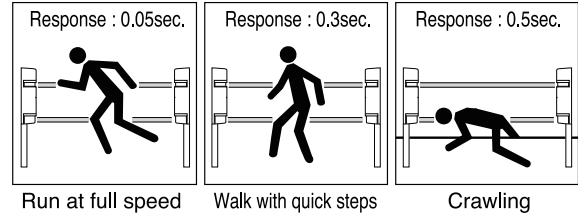
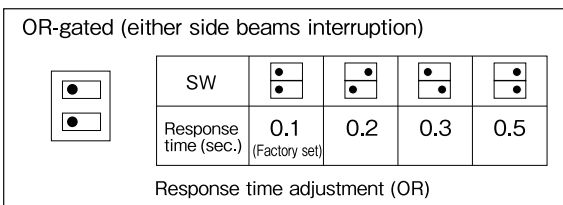
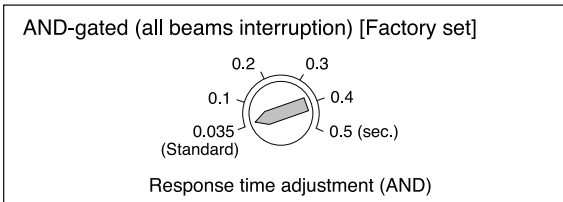

6. Environmental Module

The environmental signal is initiated if the beam reception level is reduced to approx. 25% or less.

The module "watches" for a gradual degradation of the beam reception which is indicative of extremely poor weather conditions.

7. Beam selector

Use when beam alignment is adjusted.

Only the beam reception level of the beam that is selected by the beam selector is indicated on sensitivity attenuation LED, Sound check tone and monitor output.

When a lock spacer is inserted this function is cancelled and sensitivity attenuation LED lights regardless of positioning of the selector even when either side of beam is attenuated.

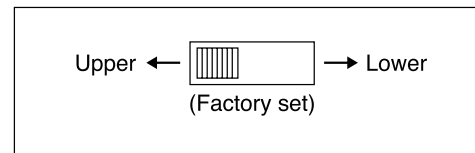

7 TROUBLESHOOTING

Symptom	Possible cause	Remedy
Operation LED does not light	<ol style="list-style-type: none"> 1. Disruption of power or inadequate power 2. Bad wiring connection or broken wire, short 	<ol style="list-style-type: none"> 1. Correct power source 2. Check and correct wiring
Receiver Alarm LED does not light when the beam is broken	<ol style="list-style-type: none"> 1. Disruption of power or inadequate power 2. Bad wiring connection or broken wire, short 3. Reflection of beam is flooding receiver and sent into the receiver 4. Beam interruption time is shorter than response time 	<ol style="list-style-type: none"> 1. Correct power source 2. Check and correct wiring 3. Remove reflecting object. Set beam power to Low. Contact TAKEX for further remedies 4. Adjust response time
Receiver Alarm LED stays lit	<ol style="list-style-type: none"> 1. Alignment is off 2. Shading object between transmitter and receiver 3. Optics of units are soiled 4. Frequency channel setting on transmitter does not match with that on receiver 	<ol style="list-style-type: none"> 1. Check and adjust 2. Check site / remove any possible obstacles 3. Clean the optics with a soft cloth 4. Readjust to be the same channel
Intermittent alarm	<ol style="list-style-type: none"> 1. Bad wiring connection 2. Change of supply voltage 3. Shading object between transmitter and receiver 4. The wiring of power machine is located nearby transmitter and receiver 5. Unstable installation of transmitter and receiver 6. Optics of units are soiled 7. Improper alignment 8. Small animals may pass through the 4 beams 9. Beam power switch is set at L, which does not keep enough sensitivity allowance 	<ol style="list-style-type: none"> 1. Check again 2. Stabilize supply voltage 3. Remove the shading object 4. Change the place for installation 5. Stabilize 6. Clean the optics with soft cloth 7. Check and re-adjust 8. Change environments or the place for installation 9. Set beam power switch at H and make the unit gain-locked with receiver cover detached

(Units should be tested on a regular weekly basis)

8 SPECIFICATIONS

9 EXTERNAL DIMENSIONS

Model	PB-100AT-KH
Detection system	Near infrared beam interruption system (TR,-RE 4 beams simultaneous interruption or upper 2 beams interruption or lower 2 beams interruption)
Infrared beam	Double modulation pulsed beam by LED
Protection distance	Outdoor 100m (330') or less
Max. arrival distance	Tenfold 1000m (3300')
Response time	Dual response time system 0.035-0.5sec. (AND gated) 0.1, 0.2, 0.3, 0.5sec. (OR gated)
Power supply	12V to 30V DC (non-polarity)
Current consumption	57mA or less
Alarm output	Dry contact relay output form C Contact action : Interruption time (Min.2sec.) Contact capacity : 30V (AC/DC) 0.25A (resistive load) Protective resistor
Environmental output	Dry contact relay output form C Action : Activated when weather condition gets worse Contact capacity : 30V (AC/DC) 0.25A (resistive load) Protective resistor
Alarm LED	Red LED (receiver) lights when an alarm is initiated
Sensitivity attenuation LED	Red LED (receiver) lights when beam reception is attenuated
Functions	Modulated beam frequency selection, Tone indicator, Environmental module, Beam power selection, Beam selector, Programmed AGC. Auto-gain lock function, Monitor jack.
Beam adjustment	Horizontal : $\pm 90^\circ$, Vertical : $\pm 10^\circ$
Ambient temperature range	-35°C to $+66^\circ\text{C}$ (-31°F to $+151^\circ\text{F}$)
Mounting position	Beam tower
Wiring	Terminals
Weight	Transmitter : 300g (10.6 oz) Receiver : 400g (14.1 oz)
Appearance	Resin

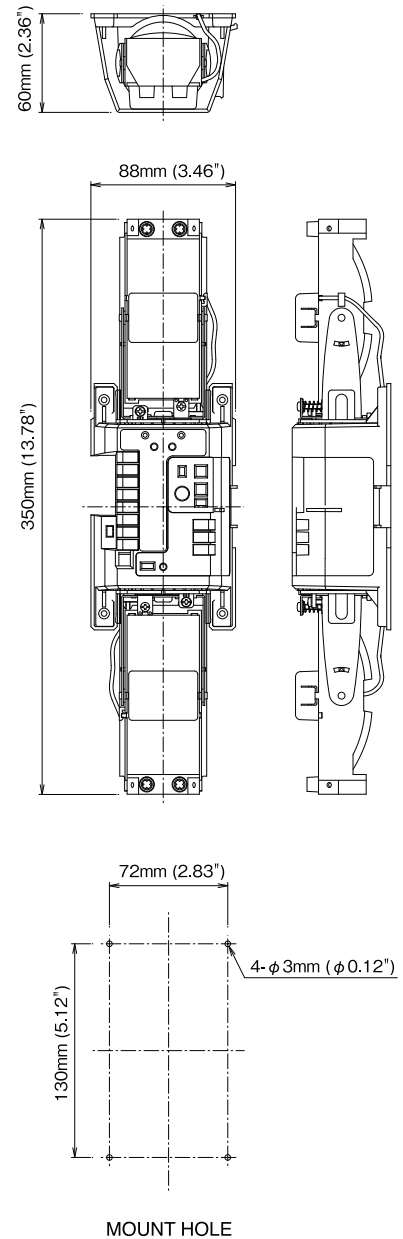

Limited Warranty :

TAKEX products are warranted to be free from defects in material and workmanship for 12 months from original date of shipment. Our warranty does not cover damage or failure caused by Acts of God (including inductive surge by lightning), abuse, misuse, abnormal usage, faulty installation, improper maintenance or any repairs other than those provided by TAKEX. All implied warranties with respect to TAKEX, including implied warranties for merchantability and implied warranties for fitness, are limited in duration to 12 months from original date of shipment. During the Warranty Period, TAKEX will repair or replace, at its sole option, free of charge, any defective parts returned prepaid. Please provide the model number of the products, original date of shipment and nature of difficulty being experienced. There will be charges rendered for product repairs made after our Warranty period has expired.

TAKEX TAKENAKA ENGINEERING CO., LTD.

In Japan

Takenaka Engineering Co., Ltd.
83-1, Gojo-Dori, Sotokan Nishi-iru, Higashino,
Yamashina-ku, Kyoto 607-8156, Japan
Tel : 81-75-501-6651
Fax : 81-75-593-3816
<https://www.takex-eng.co.jp/>

In the U.S.

Takex America Inc.
151, San Zeno WAY
Sunnyvale, CA 94086, USA
Tel : 408-747-0100
Fax : 408-734-1100
<https://www.takex.com>

In Australia

Takex America Inc.
4/15 Howleys Road, Notting Hill,
VIC, 3168
Tel : +61 (03) 9544-2477
Fax : +61 (03) 9543-2342
<https://www.takex.com>

In the U.K.

Takex Europe Ltd.
Aviary Court, Wade Road,
Basingstoke, Hampshire. RG24 8PE, U.K.
Tel : (+44) 01256-475555
Fax : (+44) 01256-466268
<https://www.takex.com>