

TAKEX PHOTOELECTRIC BEAM SENSOR

PR-30BE : OUTDOOR 30m (100 ft.) : INDOOR 40m (135 ft.)

Instruction Manual

Thank you for purchasing our photoelectric beam sensor.
This sensor will provide long and dependable service when properly installed.
Please read this Instruction Manual carefully for correct and effective use.
Please note : This sensor is designed to detect intrusion and to initiate an alarm ; it is not a burglary-preventing device.
TAKEX is not responsible for damage, injury or losses caused by accident, theft, Acts of God (including inductive surge by lightning), abuse, misuse, abnormal usage, faulty installation or improper maintenance.

1 PRODUCT DESCRIPTION

The PR-30BE, adopting Time of Flight technology, consist of a sensor (integrating both a transmitter and a receiver inside) and a reflector. As illustrated, an infrared beam, projected by the transmitter is reflected back to the receiver, forming a protection loop along the path.

When the protection loop is interrupted, the receiver initiates an alarm. The receiver not only monitors the change in the amount of light that is reflected and returned, but also measures and monitors the time (distance) of the return. As a result, stable protection line can be constructed by preventing the surrounding environment and material/color of any shielding objects from affecting the detection.

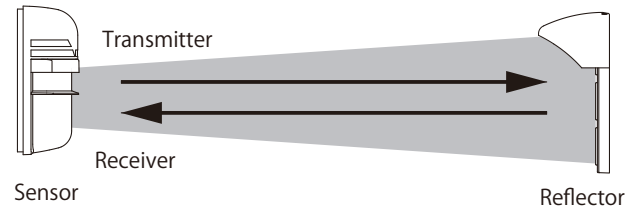

- This sensor requires only one-side wiring, so can be used in places where it is difficult to wire on two sides.
- Both beam reception level and detection distance are monitored to form a stable protection line.

- The optical unit inside the sensor is adjustable by $\pm 90^\circ$ horizontally, and $\pm 5^\circ$ vertically for flexibility in various applications.
- Beam alignment can be adjusted only on the sensor side by utilizing the viewfinder, monitor output, and sound check function.
- Environmental trouble signal is output when the beam reception level is reduced below an acceptable level.

2 PARTS DESCRIPTION

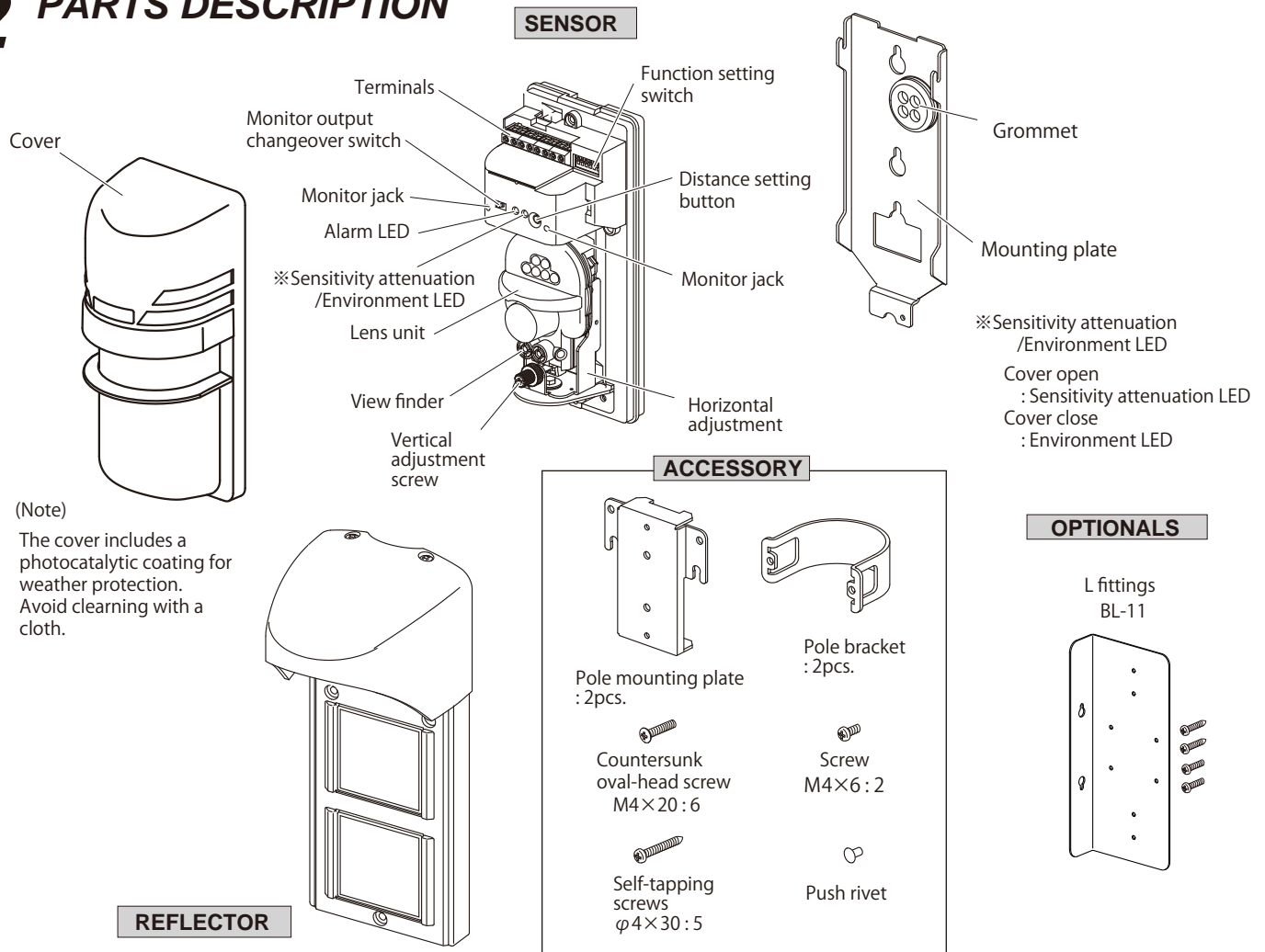

3 PRECAUTIONS

This manual describes the precautions to be observed for safe operation of this device by classifying them into the following categories. As these are important, be sure to read and strictly observe them.

Description of the Display

	Warning Indicates information that, if ignored and the device is handled incorrectly, may result in death or serious injury.
	Caution Indicates information that, if ignored and the device is handled incorrectly, may result in injury or damage to property alone.
	This symbol indicates a prohibited action, with the specific action shown near the symbol. Example: Do not disassemble
	Indicates useful information.

Warning	
Do not use the sensors powered with a voltage level other than the indicated power supply voltage specified (between 10.5 to 30V DC). It may cause a fire or electrical shock.	Do not disassemble or modify this device. It may cause a fire, electrical shock, or malfunction of the device.
Do not connect a device that exceeds the capacity shown to the output contact of this device. It may cause fire or electrical shock.	If smoke, an abnormal odor or sound is found, leaving it unattended may cause a fire or electrical shock. Immediately turn off the power to the device and confirm that the abnormal state has been corrected, and then ask the place of purchase for repair.
Do not touch the terminal section with wet hands. It may cause an electrical shock.	

Caution	
Consider the rated protection distance for each device, and use within the rated distance.	Do not install this device in a location that cannot support its weight. The device may fall and cause injury or malfunction of the device.

Do not install the device as shown below. It may cause a false alarm or a lost alarm.

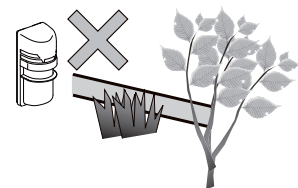

• Installation in locations shaded by trees etc.

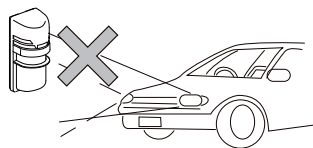

• Installation in locations where strong light such as vehicle headlights, LED lights, or IR illumination for cameras enter the optical axis.

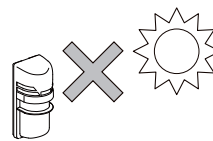

• Installation in locations where sunlight (sunrise /sunset) enters the optical axis.

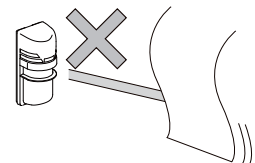

• Installation in areas where objects that move (laundry on a line, etc) can obstruct the optical axis

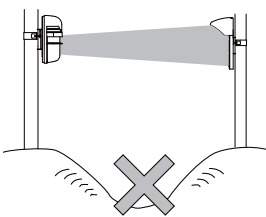

• Installation on uneven ground

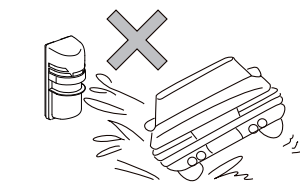

• Installation in locations where the device may be splashed by dirty water or direct sea spray

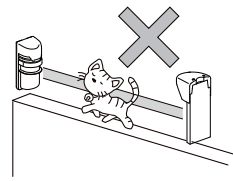

• Installation directly above a wall

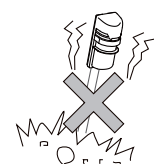

• Installation in an unstable location

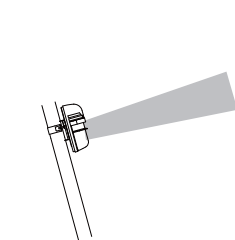

• Slanted installation

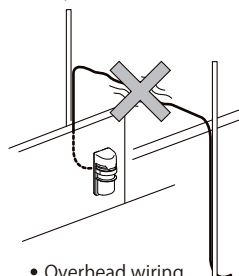

• Overhead wiring

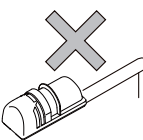

• Horizontal installation

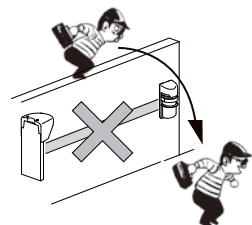

• Installation close to a wall



Cautions when using the outdoor photoelectric beam sensor (Daily maintenance)

- In areas where there are trees or weeds, the photoelectric beams may get obstructed by overgrown branches or leaves. As this may cause false detection, be sure to trim down leaves and branches according to the growth of the plants. Furthermore, the photoelectric beams may get obstructed by swaying branches or leaves due to wind. Keep in mind the swaying of leaves and branches when trimming them.
- Vine plants may wrap around the photoelectric beam sensor causing false detections. Therefore, be sure to prune such plants regularly.
- Insects, bird droppings, or other natural phenomena may also soil the sensor causing false detection. Be sure to clean the sensors regularly.

4 BEFORE INSTALLATION

In order to use this sensor correctly, thoroughly read this instruction manual and select the mounting position and protection distance.

PROTECTION DISTANCE

* Protection distance (between sensor/reflector) should not exceed the rated range. Outdoor protection distance may be reduced due to the possible effect of mist, fog, frost, rain, or condensation on the sensor unit cover and reflector unit, which can cause false alarms.

$$\phi A = 0.2 \times L$$

<Example>

$$L = 10\text{m (33')} : \phi A = \phi 2.0\text{m (6.6')}$$

$$L = 30\text{m (100')} : \phi A = \phi 6.0\text{m (20')}$$

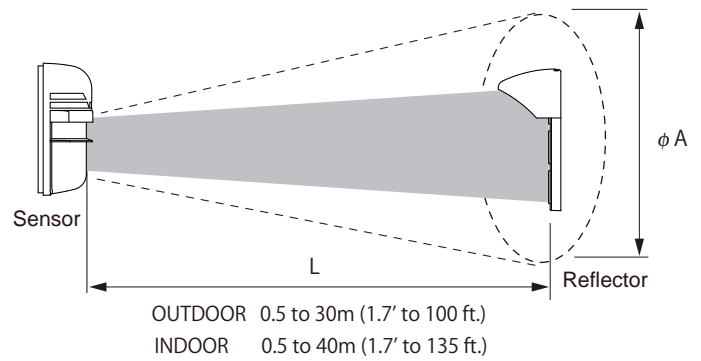

HEIGHT OF INSTALLATION

Install the sensor at a height of 80 to 100cm (31" to 39") to catch a human target. (Install vertically so that the center of the sensor lens and middle part of the reflector assembly are placed at the same height.)

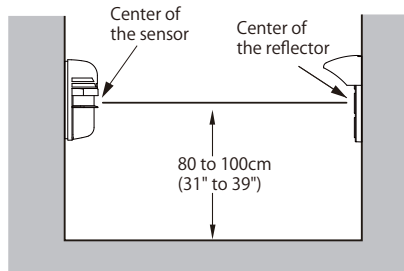

CAUTIONS ON INSTALLATION

* Align the center of the sensor with the center of the reflector (the middle of the three reflector plates) and mount them both keeping the protection line horizontal. When mounting on a pole, fix each pole mounting plate at the same height to align the center of the sensor/reflector.

POSITION OF INSTALLATION

The optical unit can be adjusted horizontally (± 90 degrees) and vertically (± 10 degrees) for various installation types. (example 1 to 3)

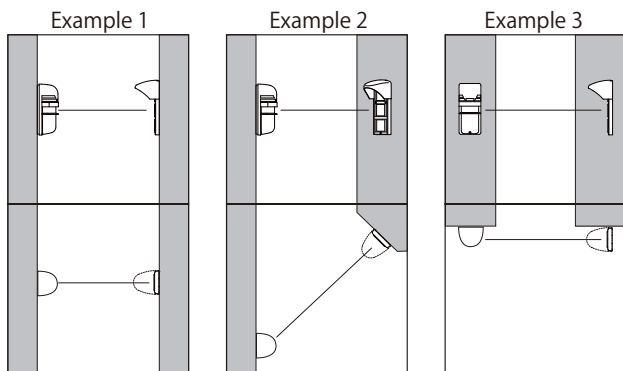

Install the reflector directly, facing the front of the optical unit as much as possible. Reflection efficiency of the reflector, due to its nature, decreases as the angle from the directly facing position increases. Make sure that angle remains within $\pm 15^\circ$ even if angled installation is needed. When exceeding this, the amount of reflected light will be insufficient and it will not operate correctly.

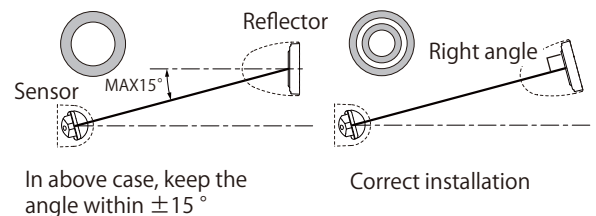

INSTALLATION OF MULTIPLE SENSORS

Multi-level / straight line installation

Do not perform multi-level protection or straight line protection (3 spans or more), to avoid malfunction or lost alarm.

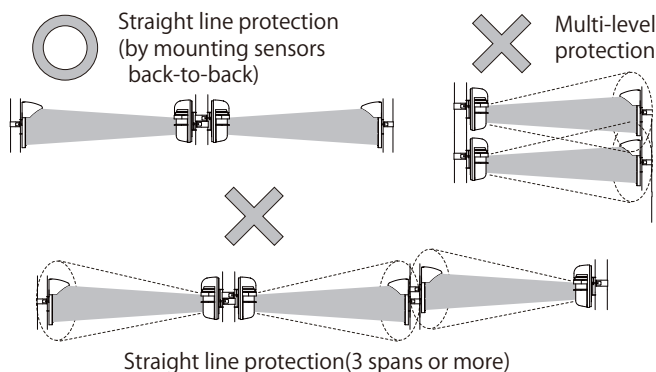

Parallel installation

In order to avoid malfunction or lost alarm caused by interference, keep the distance between each sensor when installed in parallel as below.

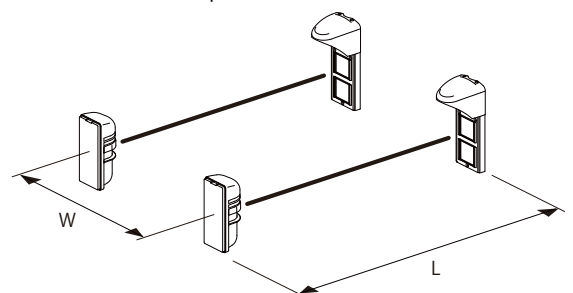

L = Within 20m (66') W = More than 2m (6.6')
 L = Over 20m (66') but within 30m(100') W = More than 3m (10')
 L = Over 30m(100') but within 40m(135') ... W = More than 4m (13.5')

5 INSTALLATION

WALL MOUNTING

•Sensor

- Remove cover from unit and slide the mounting plate upwards to detach it.

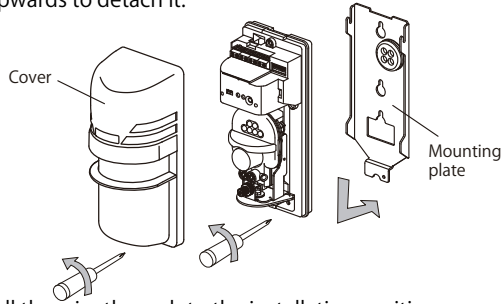

- Pull the wire through to the installation position.
- Make one hole in the grommet on the mounting plate and pull the wire through it. Secure the plate with 2 x self-tapping screws. (ϕ 4x30mm)

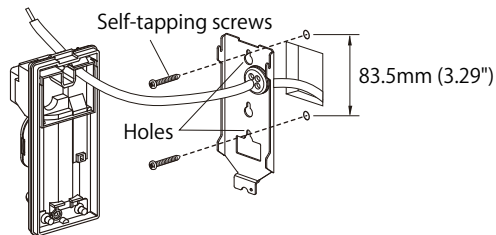

Pull the wire through the sensor body (back to front) and attach it to the terminals on the sensor.

- For exposed wiring, break knockouts (in 2 positions) on the rear of the unit, pull the wire through as per the diagram and attach it to the terminals on the sensor.

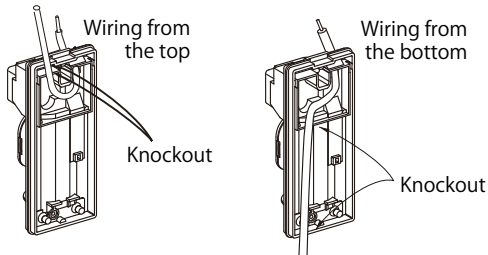

- After wiring is completed, adjust alignment, attach cover and check operation.

NOTE: When installing the sensor on a wall without roof or eaves, or where it is at risk from exposure to heavy rainfall for prolonged periods, we recommend caulking the top side of the cover as shown below.

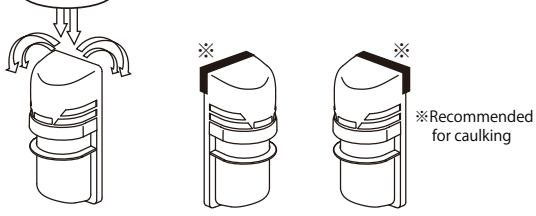

•Reflector

Fix the reflector directly facing the sensor using 3 x (ϕ 4x30mm) self-tapping screws

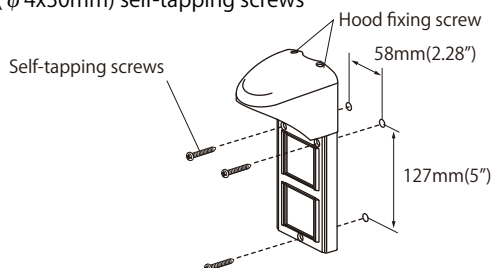

※In case of indoor installation, the hood can be removed if it is not required.

- Loosen 2 x fixing screws on the top of reflector and remove the hood.
- Remove the push rivet.
- Invert the reflector with the hood fixing holes facing downwards and fix into position with 2 x (ϕ 4x30mm) self-tapping screws using the upper and lower holes.
- Insert 2 x push rivets into the fixing screw holes to seal them.

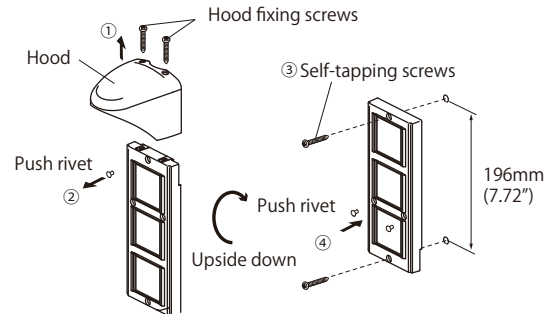

(Note) In case of outdoor installation, please do not remove hood.

POLE MOUNTING

※Applicable pole size : Outside dia. 42mm (1.65") to 49mm (1.93").

※Fix the pole mounting plates of the sensor and the reflector at the same height to adjust them to each center.

•Sensor

- Insert 2 x oval countersunk head screws (M4x20) into the pole bracket with a few turns.
- Position the pole between the pole mounting plate and the pole bracket and tighten the screws.
- Insert 2 x screws (M4x6) into the pole mounting plate with a few turns.
- Fix the sensor mounting plate to the pole mounting plate.

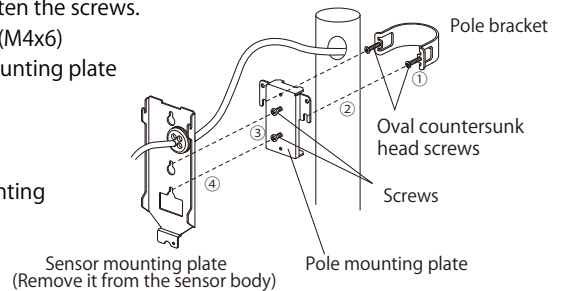

- Follow the same procedure as wall mounting (from ③) for wiring.

•Reflector

- Insert 2 x oval countersunk head screws (M4x20) into the pole bracket with a few turns.
- Hold a pole between the pole mounting plate and the pole bracket and tighten the screws.
- Fix the reflector unit to the pole mounting plate by 2 x oval countersunk head screws (M4x20).
- Insert the push rivet into the lower hole in order to seal it.

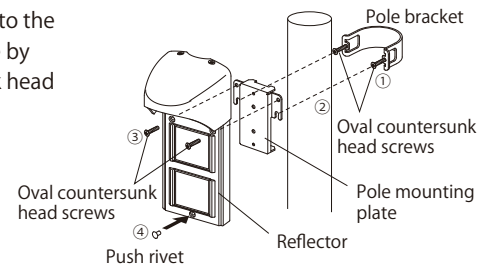

Grommet

The grommet is compatible with a wire of ϕ 3mm (ϕ 0.12") to ϕ 6mm (ϕ 0.24") outer dia. When a wire of more than ϕ 6mm (ϕ 0.24") outer dia. is used, cut the dotted line portion on the right figure using pliers or similar.

Then use caulking to prevent insects from entering the unit.

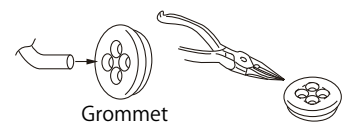

For back-to-back and right angle mounting

(Note) Applicable only to the sensor, not to the reflector.

- Fix the first pole mounting plate with first pole bracket.
- Pass the second pole bracket under the first pole mounting plate and fix the second pole mounting plate upside down.

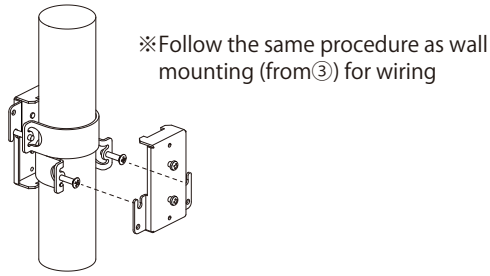

6 WIRING

TERMINAL CONFIGURATION

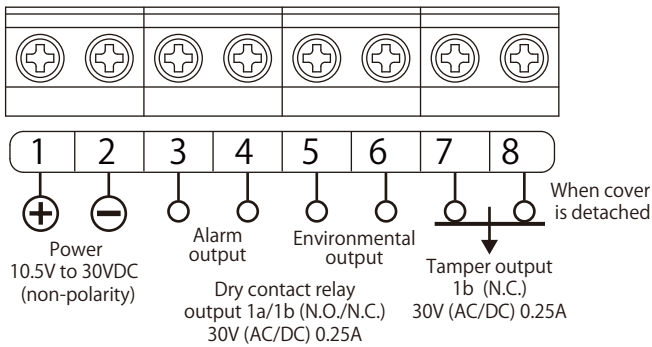

Current consumption (Max) : 200 mA (DC10.5V)
160 mA (DC12V)
80 mA (DC24V)

•Wiring distance

Wire size	Voltage	DC12V	DC24V
AWG 22 (Dia 0.65mm)		50m (165')	500m (1,650')
AWG 20 (Dia 0.8mm)		50m (165')	750m (2,500')
AWG 18 (Dia 1.0mm)		100m (330')	1,200m (4,000')
AWG 17 (Dia 1.1mm)		150m (500')	1,400m (4,600')

(note) Maximum wiring distance, when two or more sets are connected, is the value above divided by the number of sets.

7 OPTICAL AXIS ADJUSTMENT

By aligning the optical axis correctly, a protection line with sufficient margin of sensitivity can be created, reducing the occurrence of malfunction. Apply both "Distance check" and "Light reception level check" properly as shown below.

1 Before checking

- When mounting is completed, adjust the lens unit horizontally (left and right direction) to face the reflector. Mount the reflector so that it directly faces the front of the lens unit as much as possible. The beam path should be as close to parallel as possible to ensure reliable operation. Make sure that angle remains within $\pm 15^\circ$ even if angled installation is needed. When exceeding this, the amount of reflected light will be insufficient and it will not operate correctly.

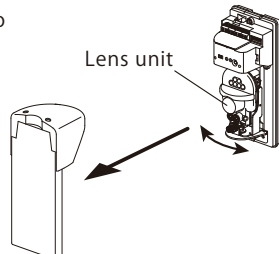

- Adjust the angle of the sensor with vertical adjustment screw by looking through the viewfinder. Continue adjust until the center of the reflector can be seen in the middle of the viewfinder as shown on the right.

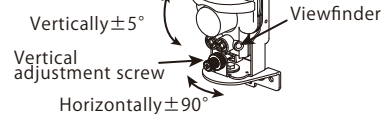

Inside the viewfinder

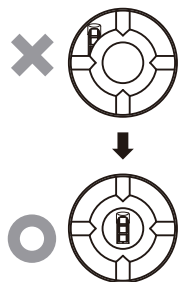

- Adjustment with the viewfinder may cause some difference depending on the viewpoint as it is only a rough adjustment. Therefore, make sure to complete both "2. Distance check" and "3. Light reception level check".

- Supply power to the sensor.

Installation with BL-11 (Sold separately)

(Note) Applicable only to the sensor, not to the reflector.

- Fix the BL-11 to the wall by 2 x self-tapping screws. ($\phi 4 \times 20 \text{mm}$) (using keyhole)
- Fix the reflector to the BL-11 by 2 x oval countersunk head screws (M4x20).
- Insert the push rivet into the lower hole in order to seal it.

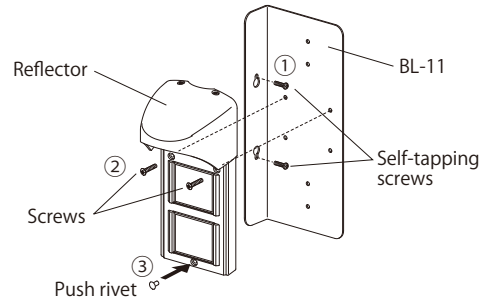

CONNECTION

•Example connection 1

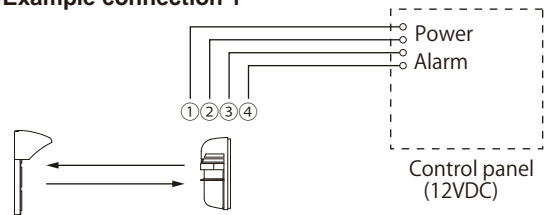

•Example connection 2

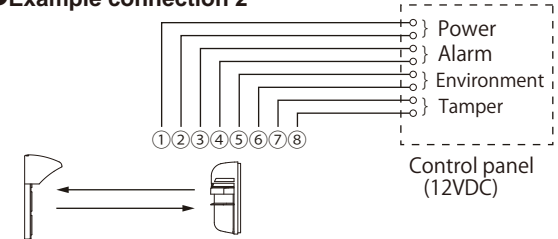

•Example connection 3

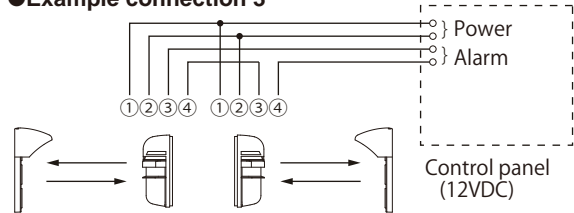

2 Distance check

- ① Ensure that the monitor output changeover switch is set to "Distance". When adjusting the optical axis by changing the installation distance, long press the distance setting button (short pip for 5 seconds or more) before proceeding to the next step.

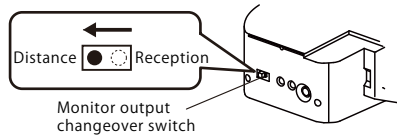

- ! Especially at short distance, the high-power beam output from the transmitter may reflect on objects (walls, signboards, utility poles, etc.) near to the protection line. Therefore, adjust correctly when installing.

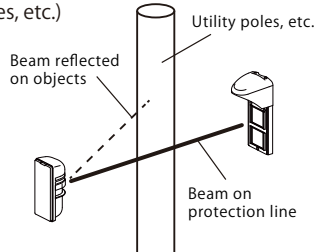

- ③ Insert a test meter into the monitor jack and check the voltage. Monitor output level corresponds to the distance.

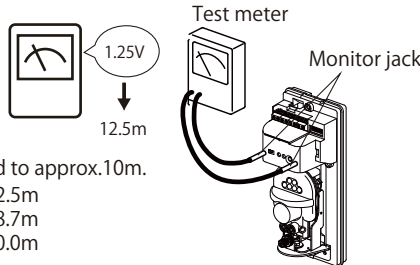

- ③ If the distance to the reflector and the converted value of the test meter do not match, fine adjust the optical axis of the lens unit or remove any objects near to the protection line.

Ex) When the distance from the sensor to the reflector is 15 m

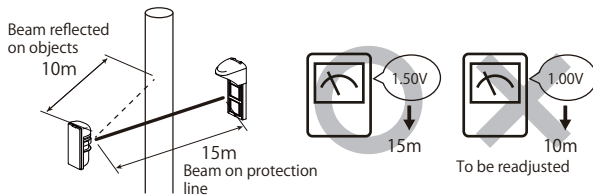

- ④ Press the distance setting button. The distance between the sensor and the reflector is set while pip is sounding. Be careful not to block the optical unit (protection line) with your body or hands.

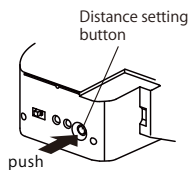

! IMPORTANT

By this operation, the distance between the sensor and the reflector is memorized so that the adjustment and alarm judgment are properly performed. So be sure to press the distance setting button. Before pushing this button, the pitch of tone indicator and monitor output voltage are kept based on the previous setting. So be sure to make adjustment after pressing the button. ※Once memorized, the setting will not be reset without pressing the button again, even if the power is turned on again. When incorrect distance is set, go back to [2. Distance check] and do the setting again.

3 Light reception level check

- ① For the light reception level check, set the monitor output changeover switch to "Reception".

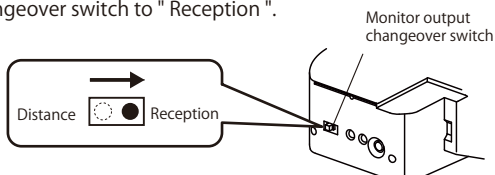

- ② Set tone indicator setting to "ON". If the tone indicator is undesirable (at night), proceed directly to ④.

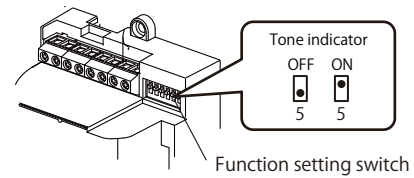

- ③ Fine-tune the optical unit the tone becomes continuous and as high-pitched as possible.

(Note)

If no sound comes out, the sensor unit may not face the direction of the reflector. In this case, go back to [1. Before checking] and do the setting again. Also check that the tone indicator switch is ON.

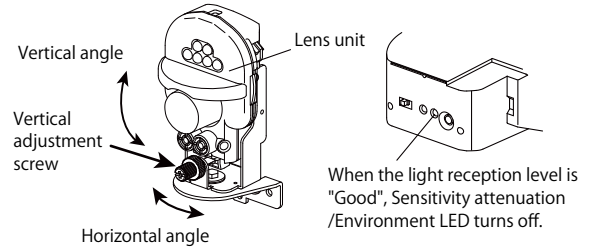

When the direction of the optical axis roughly matches the reflector, a beep sound begins which changes according to the light reception level as below.

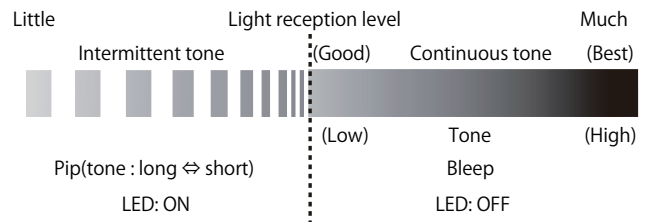

- ④ For more accurate adjustment, insert a test meter into the monitor jack and check the voltage.

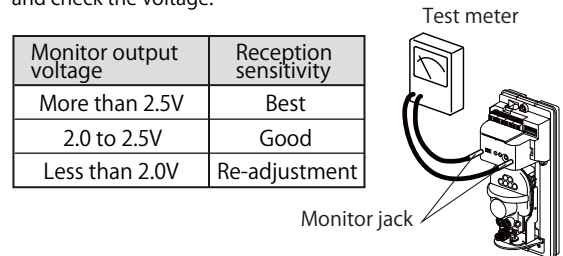

- ! As a guide, the monitor voltage is shown in the above table. However, adjust the sensitivity to as high level as possible in order to improve environmental resistance.

- ! The monitor voltage of the light reception level may change due to the ambient temperature or just after turning on the power.

- ⑤ Replace the cover and tighten the fixing screw.

Once the cover is fixed, the unit automatically starts adjusting the transmission power with short pip sound. Be careful not to block the optical unit (protection line) with your body or hands until pip sound stops. (It may take max. 10 sec.)

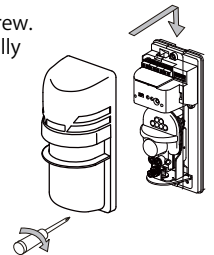

- ➔ If pip sound stops, the optical axis adjustment is completed. In case pip sound continues, go back to [2. Distance check] and do the setting again.

In case tone indicator is "ON", walk test mode follows for 5 minutes and makes pip sound when detecting.

→ Refer to "9. OPERATION CHECK"

※Once walk test mode is completed, no pip sound is heard even with the tone indicator "ON".

8 FUNCTIONS

① Alarm output changeover
(Function setting switch: DIP 1)
N.C. or N.O. can be selected for alarm output logic.

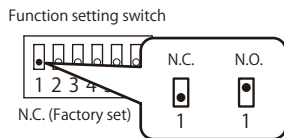

② Environmental output changeover
(Function setting switch: DIP 2)
N.C. or N.O. can be selected for environmental output logic.

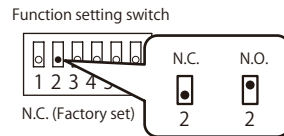

! Environmental output setting:
When the light reception level reaches the prescribed level or less for the following reasons, the environmental contact output and LED will activate.

- Protection line obstructed due to growing trees and weeds
- Dirt on the surface of sensor cover and reflector
- Environmental deterioration caused by thick fog, blizzard, snow cover
- Incorrect alignment of optical axis of sensor and reflector, etc.

In such cases, take appropriate measures like cutting trees, cleaning the device, adjusting optical axes and so on, so that the light reception is restored to the prescribed level or more.

(Signal output continues min. 5 sec. until the light reception is restored to the prescribed level or more)

Sensitivity attenuation / Environment LED : ON



! It may take some time (max. a few minutes) for the environmental output to recover even if the environment is restored. Press the distance setting button for immediate recovery.

⊘ Be sure to wash the sensor cover only with water without wiping it with a cloth.

③ Response time adjustment (Function setting switch: DIP 3/4)
The detectable interruption time can be selected.
(Refer to the diagram below to adjust the response time.)

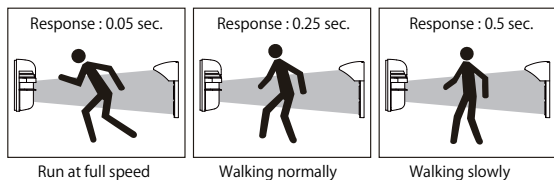
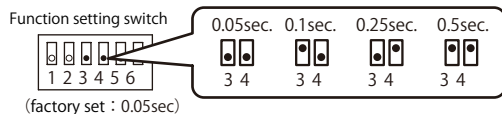

<Caution>

- If the interruption time is shorter than the response time, there is no detection of obstructing object.
- If there is a possibility that large flying objects (birds, falling leaves, etc.) shield the optical axis, set the response time longer, considering the installation conditions.

④ Tone Indicator (Function setting switch : DIP 5)
When tone indicator switch is ON, reception level is notified with sound. (Only when Monitor output switch is set to "Reception")
• As the light reception level increases, the sound changes from intermittent tone to continuous tone, and the pitch increases after that.
• This function operates only when the sensor cover is removed.

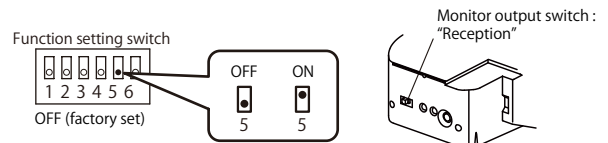

Also, when selecting "ON", walk test mode starts after closing of the cover.

※Walk test mode

For 5 minutes after closing the cover, a pip sound is emitted when crossing the protection line, for easy operation check.

(It automatically stops after 5 minutes)

To extend the time for another 5 minutes, open the cover and close it again. Repeat this action to extend the time further.

⑤ Detection mode changeover
(Function setting switch : DIP 6)
Depending on the environment of the installation location, "Normal" or "Harsh" can be selected.

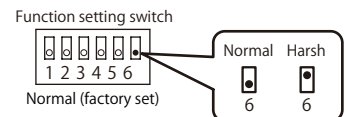

Select "Normal" mode (factory set) as regular setting. When setting to "Harsh", read the section of [Detection mode changeover] below carefully and fully understand the content before use.

⑥ Monitor output
"Distance" or "Reception" can be selected when adjusting the optical axis using a test meter. When set to "Distance", you can check the distance to the reflector. Use it when there are reflective objects near the protection line.

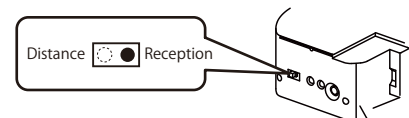

※Refer to "7 OPTICAL AXIS ADJUSTMENT" for further detail.

! Detection mode changeover

Select "Normal" mode (factory set) as regular setting.
This device is designed to emit an infrared beam from the sensor body, monitor the change in the amount of light returning from the reflecting object and the change in the distance to the reflecting object and output an alarm signal when they exceed the prescribed value.

In "Normal" mode, lost alarm caused by light wraparound can be prevented by monitoring these two changes.

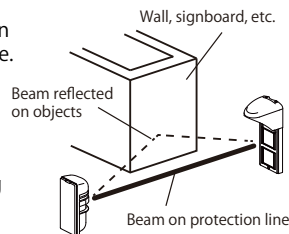

However, when the environment suddenly changes in a short period of time (such as concentrated torrential rain, rapid thick fog or snowstorm), the amount of light reflected and returned may change so suddenly that an alarm signal is output.

If this happens occasionally, set the detection mode to "Harsh" mode. "Harsh" mode monitors only the change in the distance to the reflecting object, which makes it difficult for a false alarm signal to be output even if there is a sudden change in the environment.

※"Environmental output" is output regardless of detection mode.

On the other hand, in the "Harsh" mode, wraparound of the light may not be prevented. Recheck the operation, such as whether the alarm signal is always output when crossing the protection line, and start operating the device.

9 OPERATION CHECK

After mounting the sensor and the reflector, wiring and making the alignment adjustment, check the operation of the sensor with its cover attached by looking at the alarm LED.

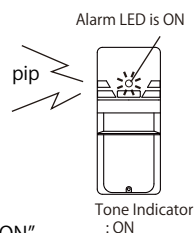

※When setting tone indicator to "ON", walk test mode starts 5 minutes after closing the cover, and pip sound comes out for alarm.

- ① Make sure that the alarm LED is off (in alarm condition) and confirm that there is nothing to block the infrared light.
- ② Cross the infrared light in various places on the protection line and check the operation. Confirm that the alarm LED is ON (alarm condition).
- ③ The device is operating normally if the alarm LED changes from ON (alarm) to OFF (protection) when you cross the infrared light.
- ④ Check also the operation of the connected system. Alarm is output during the light interruption time or for 2 seconds when light is blocked for less than 2 seconds.

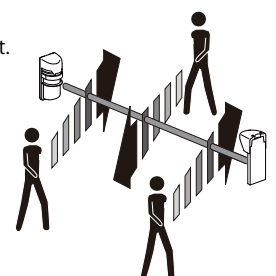

10 TROUBLESHOOTING

Symptom	Possible cause	Remedy
Alarm LED does not light when the beam is broken.	1) No power supply. 2) Bad wiring connection or broken wire, short. 3) Beam is reflected on another object and sent into the receiver.	1) Turn on the power supply. 2) Check wiring. 3) Remove the reflecting object or change beam direction
Alarm LED continues to light.	1) Beam alignment is incorrect. 2) Shading object between sensor and reflector. 3) Sensor cover or reflector are soiled. 4) Protection distance exceeds 40m. (30m outdoor)	1) Check and adjust again. 2) Remove the shading object. 3) Clean the reflector with a soft cloth, or wash the cover water. * Do not clean the cover with a cloth. 4) Keep protection distance within 40m. (30m outdoor)
Intermittent alarm	1) Bad wiring connection. 2) Unstable supply voltage. 3) Shading object between sensor and reflector. 4) A large electric noise source such as power machine is located nearby sensor. 5) Unstable installation of sensor and reflector. 6) Sensor cover or reflector are soiled. 7) Improper alignment. 8) Big birds may pass through the beams.	1) Check again. 2) Stabilize supply voltage. 3) Remove the shading object. 4) Change the place for installation. 5) Stabilize the installation. 6) Clean the reflector with a soft cloth, or wash the cover water. * Do not clean the cover with a cloth. 7) Check and adjust again. 8) Set the response time longer. (Do not use this setting where an intruder can run at full speed through the beam.)

◁(Daily check) Check the operation of the unit once a week. If the cover becomes soiled, wash it with water. Never clean it with a cloth otherwise it could damage the photocatalytic coating applied to the sensor cover. The coating is designed to prevent attenuation of the infrared caused by waterdrops from torrential rain.

11 SPECIFICATIONS

Model	PR-30BE
Detection system	Near infrared beam interruption system (reflective)
Protection distance	Outdoor 1.7 to 100' (0.5 to 30m) Indoor 1.7 to 135' (0.5 to 40m)
Supply voltage	10.5V to 30V DC (Non-polarity) (Class 2 powered device)
Current consumption	200 mA or less 160 mA or less (12V DC) 80 mA or less (24V DC)
Alarm output	Dry contact relay Dry contact relay N.O. /N.C. Contact capacity : 30V (AC/DC) 0.25A or less Relay operation : Interruption time (minimum 2 secs)
Environmental output	Dry contact relay Dry contact relay N.O. /N.C. Contact capacity : 30V (AC/DC) 0.25A or less
Tamper output	Dry contact relay 1b (N/C) Action : Activated when cover is detached. Contact capacity : 30V (AC/DC) 0.25A or less
Response time	0.05 / 0.1 / 0.25 / 0.5sec.
Alarm LED	Red LED ON : when an alarm is initiated
Sensitivity attenuation /Environment LED	Red LED When front cover detached (when alignment) : Beam is attenuated. When front cover attached : Weather condition gets worse. (Synchronize with Env.output)
Functions	• Monitor output • Response time adjustment
Ambient temperature range	-13°F to +140°F (-25°C to +60°C)
Mounting positions	Outdoor/Indoor
Wiring	Terminals
Weight	Sensor : 13oz (370g) Reflector : 6.7oz (190g)
Appearance	Sensor : Resin (wine red) Reflector : Resin (clear / black)

*Specifications are subject to change without notice.

◁Caution>

The suitability of this device with respect to reducing casualty hazards or providing a safety function is to be determined in the end-use application.

Limited Warranty :

TAKEEX products are warranted to be free from defects in material and workmanship for 12 months from original date of shipment. Our warranty does not cover damage or failure caused by natural disasters, abuse, misuse, abnormal usage, faulty installation, improper maintenance or any repairs other than those provided by TAKEEX. All implied warranties with respect to TAKEEX, including implied warranties for merchantability and implied warranties for fitness, are limited in duration to 12 months from original date of shipment. During the Warranty Period, TAKEEX will repair or replace, at its sole option, free of charge, any defective parts returned prepaid. Please provide the model number of the products, original date of shipment and nature of difficulty being experienced. There will be charges rendered for product repairs made after our Warranty Period has expired.

12 EXTERNAL DIMENSIONS

Unit : mm (inch)

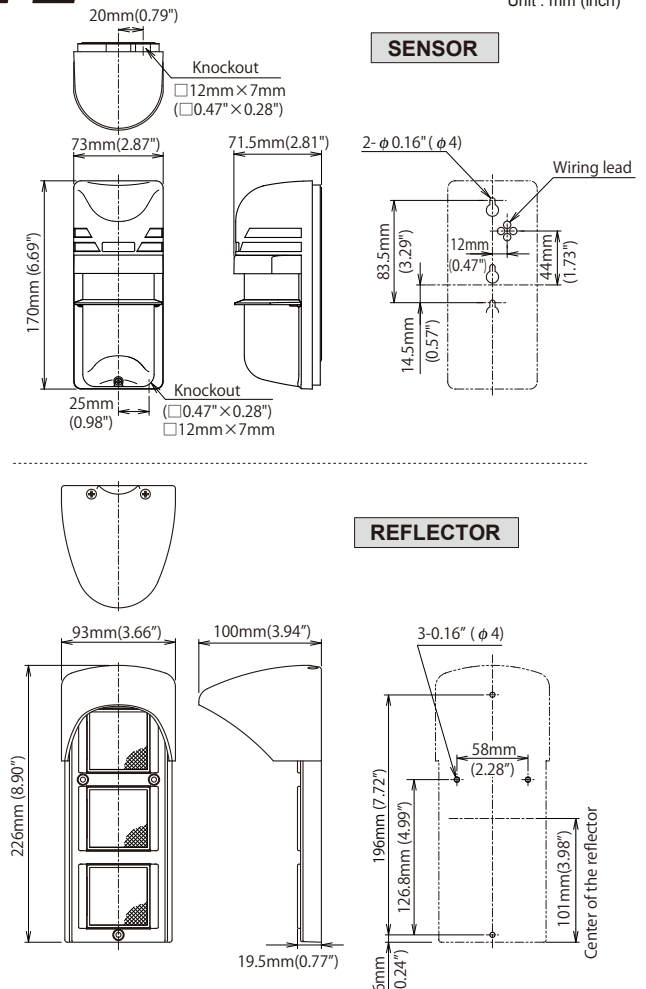

TAKEEX TAKENAKA ENGINEERING CO., LTD.

In Japan
Takenaka Engineering Co., Ltd.
83-1, Gojo-Dori, Sotokan Nishi-iru, Higashino,
Yamashina-ku, Kyoto 607-8156, Japan
Tel : 81-75-501-6651
Fax : 81-75-593-3816
<https://www.takeex-eng.co.jp/>

In the U.S.
Takex America Inc.
151, San Zeno WAY
Sunnyvale, CA 94086, USA
Tel : 408-747-0100
Fax : 408-734-1100
<https://www.takeex.com>

In Australia
Takex America Inc.
4/15 Howleys Road, Notting Hill,
VIC, 3168
Tel : +61 (03) 9544-2477
Fax : +61 (03) 9543-2342
<https://www.takeex.com>

In the U.K.
Takex Europe Ltd.
Aviary Court, Wade Road,
Basingstoke, Hampshire. RG24 8PE, U.K.
Tel : (+44) 01256-475555
Fax : (+44) 01256-466268
<https://www.takeex.com>



PR-30BE: FOR PARALLEL INSTALLATION OF MULTIPLE SENSORS

(additional explanation to "4 BEFORE INSTALLATION" in the Instruction)

When installing multiple sensors side by side for direction determination purpose, etc., refer to the table below to separate each sensor with standard distance "W", in order to avoid malfunction or lost alarm caused by interference.

● Pararel Installation

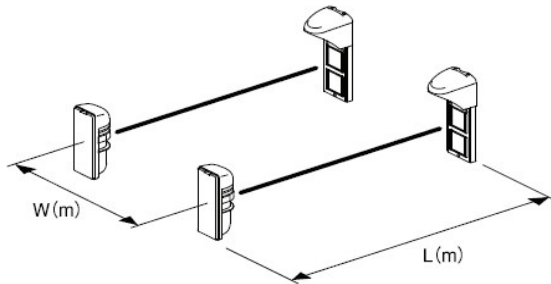

(Example of distance "W" between sensors)

L (Protection distance)	W (Standard)	W [*Conditional]
5m	2m or over	0.5m or over
10m	2m or over	1m or over
25m	3m or over	2.5m or over
$30 < L \leq 40m$	4m or over	4m or over

*(NOTE)

The sensor can be installed at the distance calculated by the formula on the right, **only if all of the following three conditions are met.**

$$W(\text{Conditional}) \geq L \times 0.1 \quad (\text{m})$$

【Condition】

- (1) Two sensors shall be installed in parallel and in the same orientation, with their reflectors rightly facing respective sensors.
- (2) "Normal" mode shall be selected with Detection mode changeover "DIP 6".
- (3) Light reception level from the paired reflector shall be DC2.5V or more at the monitor output voltage, and the influence from the adjacent reflector shall be 0.3V or less at the monitor output voltage.

《 Alignment procedure to fullfil above (3) 》 ★Both sensor shall be adjusted.

1. Mask the adjacent reflector (completely blocking infrared rays) :

2. Adjust optical axis :

Make adjustment so that the monitor output voltage achieves "best (DC2.5V or more)".

3. Check the effect of adjacent reflector:

Remove the masking from the adjacent reflector and mask the facing reflector. Check the monitor output voltage of the sensor and confirm that it is DC 0.3V or less.

4. If the above measurements are not obtained:

The distance between the sensors may be shorter than the above, or the installation environment may be special.



CAUTION

<Additional Accessory>
Optical filter for short distance.

When the protection distance is less than 5 m,
attach the filter as follows;

※ Be sure to adjust the optical axis with this filter
attached.

★ Attach the filter so that six LED can be seen
after peeling off the double side tape.

