

J SERIES Instruction Manual

Head office : 5-22 Higashino Kitainoue-cho, Yamashina-ku,
Kyoto 607-8141, Japan
Telephone : +81-75-581-7111
FAX : +81-75-581-7118

SPECIFICATIONS

Type	Normal function			Timer function			
Models	Relay output	JT10R	JRM3R	JR07	JT10RF	JRM3RF	JR07F
	Triac output	JT10R-SR	JRM3R-SR	JR07-SR	JT10RF-SR	JRM3RF-SR	JR07F-SR
Detection method	Through beam	Polarized retroreflective	Diffuse reflective	Through beam	Polarized retroreflective	Diffuse reflective	
Range	10m	0.03 to 3m ※1	700mm ※2	10m	0.03 to 3m ※1	700mm ※2	
Light source	Red LED		Infrared LED	Red LED		Infrared LED	
Power supply	24V to 240V AC/DC ±10% 50/60Hz						
Consumption (Max.)	Trns. : 2W Rcvr. : 2W	2W		Trns. : 2W Rcvr. : 2W	2W		
Operating mode	Light ON/Dark ON selectable						
Timer				ON delay, OFF delay, One shot, or no timer			
Timer interval				0.1 to 1s or 1 to 10s			
Output mode	Relay output 1a Triac output 1a						
Rating	Relay output models : AC250V, 2A, Resistive load Triac output models : AC250V, 100mA						
Obj. resolution	φ 16mm (Max.)			φ 16mm (Max.)			
Response time	Relay output : 5 ms (Max.) Triac output : 12ms (Max.)						
Ambient light	Withstands 10,000 lx						
LED indicators	(Trns.) Power (Red LED) (Rcvr.) Output (Red LED) Stability (Green LED)	Output (Red LED) Stability (Green LED)		(Trns.) Power (Red LED) (Rcvr.) Output (Red LED) Stability (Green LED)	Output (Red LED) Stability (Green LED)		
Sensitivity	None		Adjustable	None		Adjustable	
Beam deviation	5° (Receiver)	30° (Reflector)		5° (Receiver)	30° (Reflector)		
Hysteresis			10% (Max.)			10% (Max.)	
Operating temp.	-25 to +55°C						
Humidity	Withstands 85%RH						
Case protection	IP66						
Dielectric withstanding	AC1500V, 1 min						
Insulation resistance	DC500V, 100MΩ						
Vibration	10 to 55Hz, 1.5mm Amplitude, 2 HR, 3 Directions						
Case material	Acrylic						
Connection	Terminal connections, (M3.5 Screw)						
Weight (Max.)	Trns. : 250g Rcvr. : 250g	250g		Trns. : 250g Rcvr. : 250g	250g		

(※1) K-7 Reflector is used.
(※2) 200×200mm white paper

INSTALLATION AND WIRING

- Make sure all connections are correct before turning the power on.
- Use screws G1/2 when wiring with conduit.
- Use cables of 9mm to 11mm in diameter.
- When using a crimp terminal, use one fit to M3.5 screw.
The tightening torque should be 0.5N·m or less.
- Use a metal conduit to avoid malfunction or damage caused by induction when the wiring should be laid close to high-voltage cables or power lines.

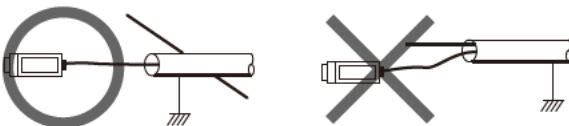

OPERATING MODE

● Normal function type

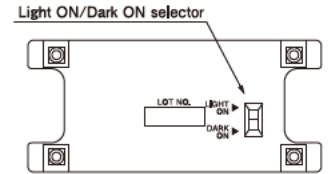

● Timer function type

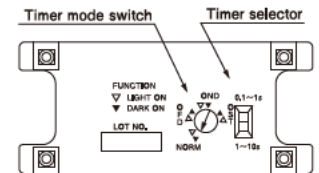

OUTPUT CIRCUIT AND WIRING

● Relay output models

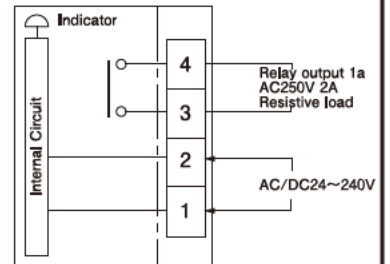

● Triac output models

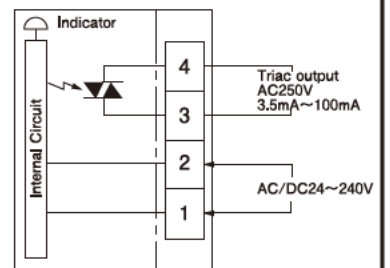

TIMING CHART (Triac output)

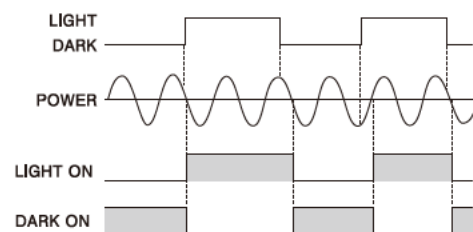

TIME & SENS. VOLUME

Model
• JR07
• JR07-SR

Model
• JRM3RF
• JRM3RF-SR
• JT10RF
• JT10RF-SR

Model
• JR07F
• JR07F-SR

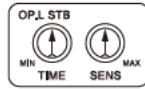
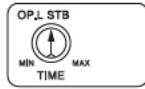
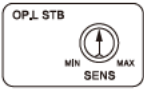

- **TIME** : Adjust timer from 0.1 to 1 or 1 to 10 seconds. (Increase time by turning clockwise.)
- **SENS.** : Sensitivity adjustment. (Higher sensitivity with Clockwise rotation.)

INDICATORS

STB. : Stable indicator (Green), OP.L : Operating indicator (Red).

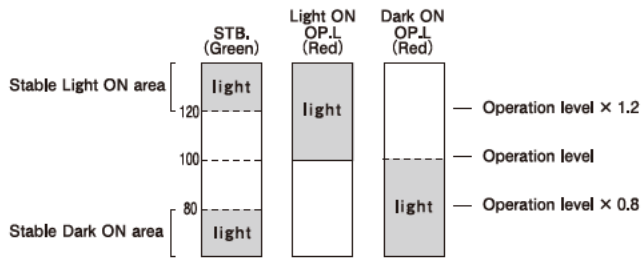

ADJUSTMENT

● Through beam type

Select Light ON mode and install the transmitter and the receiver linearly. Swing the transmitter upward/downward and left/right and find the range where the stability indicator (green) turns on while the operation indicator (red) turns on, then direct the sensor in the center of the range to align the optical axis.

(Pinhole plate)

Pinhole plate reduces the size of activation area and detection objects.

Pinhole stickers shown below are separately available for through beam models. Put the pinhole sticker on the optical window of the transmitter and/or the receiver.

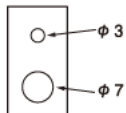

Model : JP37

Pinhole	φ 3 mm	φ 7 mm
Detecting distance	2.5m	6m

● Polarized retroreflective type

Align the optical axis in the same way as the Through beam type. Mirror like objects like steel, aluminum or plastic plates may be stably detected by installing the sensor at a slight angle against the horizontal and/or vertical lines.

● Diffuse reflective type

When any light reflecting object is in the background.

1. Place a detection object at a given position and turn up the sensitivity adjustment volume from MIN until the Operation indicator (red LED) turns on (Point A).
2. Remove the object and turn down the sensitivity adjustment volume from MAX until the operation indicator turns off (Point B).
3. Set the volume at the middle point between Points A and B.
4. Make sure both the operation indicator and the stability indicator (green LED) turn on when the detection object is placed at the given position.



TIMING CHART

● NORMAL FUNCTION

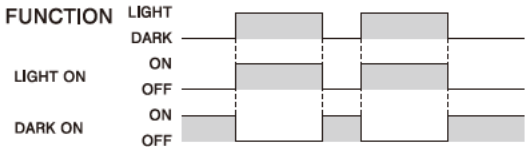

● TIMER FUNCTION

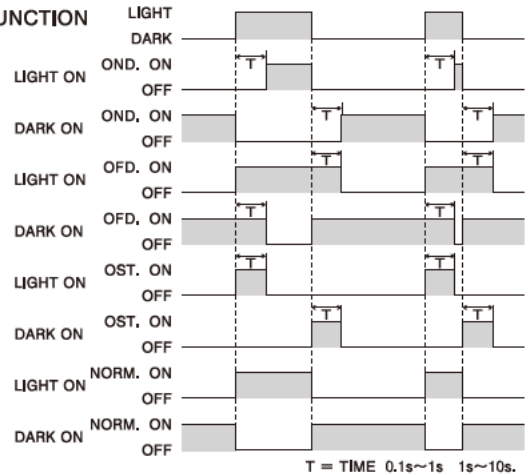

T = TIME 0.1s~1s 1s~10s.

NOTES

- Fix the sensor housing and the base firmly by the screws.
- Clean the lens and case by a soft cloth. Do not use organic solvent such as alcohol or thinner.
- Avoid switching on and off the power consecutively.
- Though this sensor has IP66 rated housing do not use the sensor where water being sprayed at all times or under the water.
- Connect an auxiliary relay. The internal relay cannot be replaced.
- Use power supply which is limited the current in accordance with the lead wire size of the sensor.

DIMENSIONS (unit : mm)

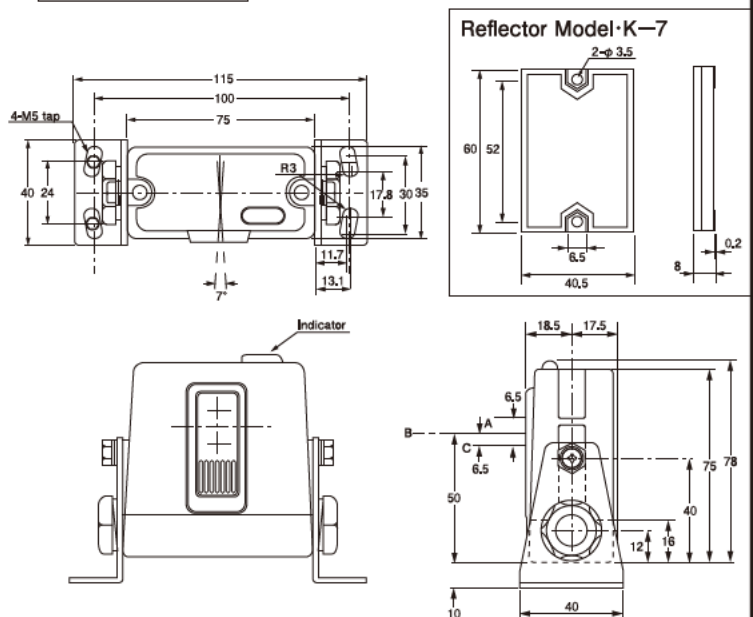

- The guarantee period of this product is one year after the delivery.
- If any defect is found during the guarantee period, Takenaka will repair or replace the defective product.
- This product is an industrial sensor which issues an output upon detecting an object. It does not have any function to prevent accidents, death or injuries.
- Takenaka will not held responsible for any damage or loss incurred due to accidents, faulty installation, abuse, misuse, improper maintenance or acts of God including lightning surge.