

TAKEX

TWIN MIRROR PASSIVE INFRARED SENSOR

Wide angle protection : PA-6612E

Instruction Manual

We appreciate your purchase of a TAKEX passive infrared sensor. This sensor will provide long and dependable service when properly installed. Please read this Instruction Manual carefully for correct and effective use.

Please Note : This sensor is designed to detect intrusion and to initiate an alarm ; it is not a burglary-preventing device.

TAKEX is not responsible for damage, injury or losses caused by accident, theft, Acts of God (including inductive surge by lightning), abuse, misuse, abnormal usage, faulty installation or improper maintenance.

1 PARTS DESCRIPTION

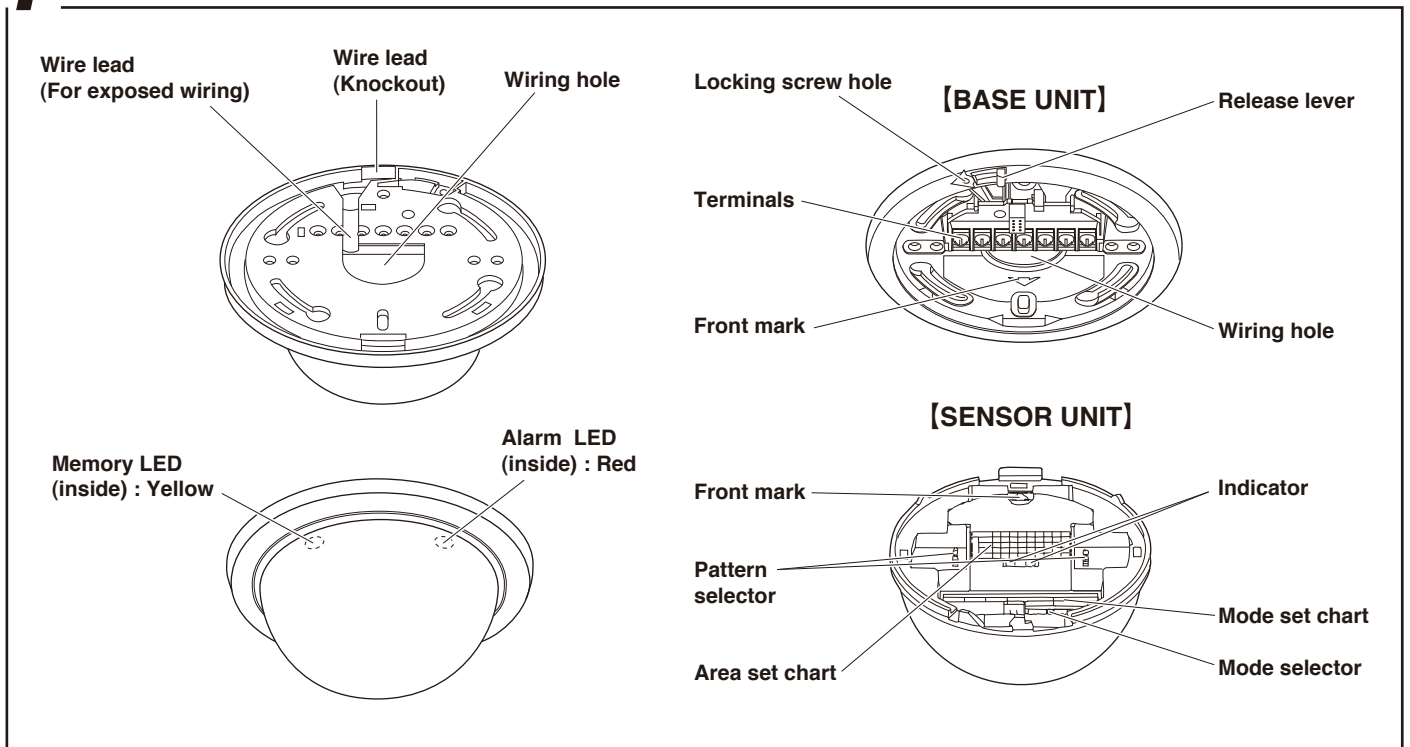

2 COVERAGE AND RANGE

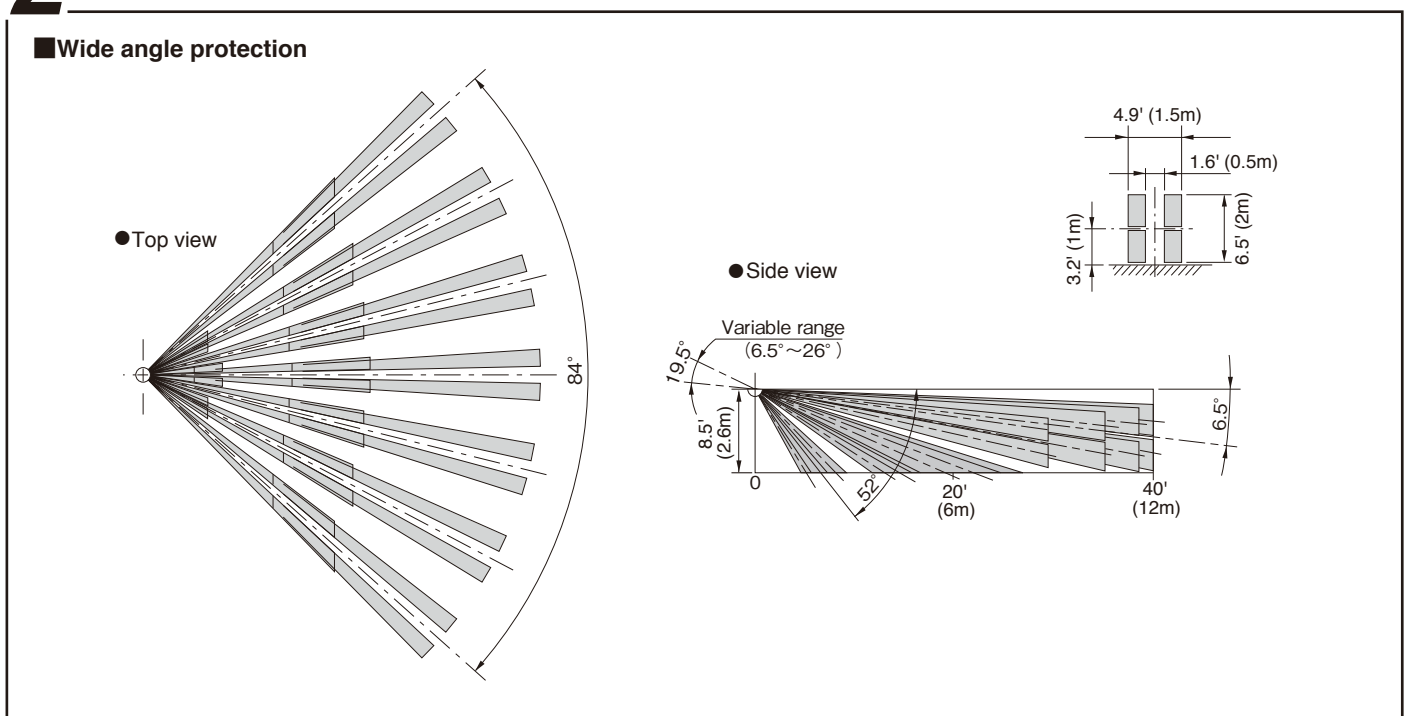

3 DO'S AND DON'T'S

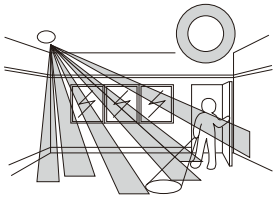

● Install the sensor in a location such that intruders are more likely to cross the protection zones, rather than approach head on.

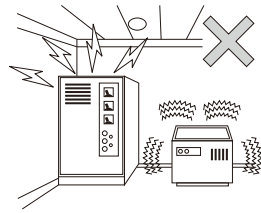

● Do not install in a site which is subject to electrical noise or intense vibration.

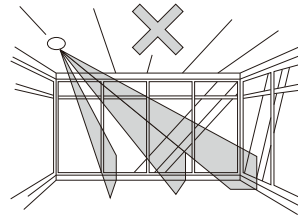

● Avoid direct sunlight, spot light or intense reflections on the sensor or the protection zone.

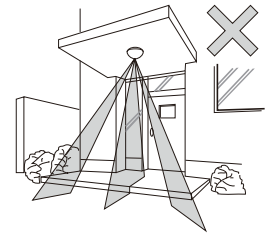

● Do not install the sensor outdoors (indoor only).

[MAINTENANCE]

1. When the unit is soiled, clean the cover with a soft cloth moistened with a small amount of cleansing solution. Do not use chemicals such as thinners or alcohol.
2. Check operation once a week. Do not fail to check operation whenever furniture in coverage area is moved.

● The passive infrared sensor is designed to detect infrared energy variations caused by the presence of a human body. Therefore, note that similar variations in conditions in protection area, due to other reasons, may cause the sensor to create an alarm as it is unable to distinguish between sources.

4 INSTALLATION

- (1) Slide release lever to a direction that an arrow points to detach sensor unit from base unit.

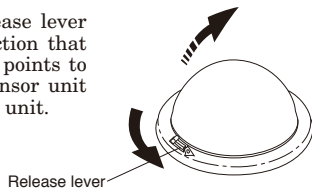

- (2) Mount the base on the ceiling with screws. Fix so that the front mark (↑) is pointing to the center of protection area.

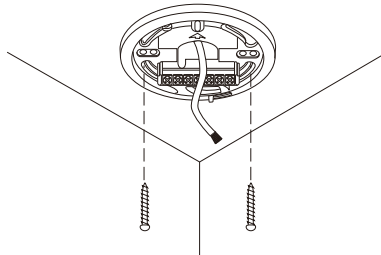

* Break knockout and put the wire through wire lead on base unit, when exposed wiring.

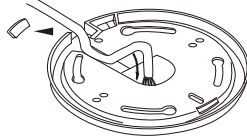

- (3) Connect the wires to the terminals referring to the paragraph on WIRING.

- (4) Set the protection area referring to the paragraph on PATTERN SETTING.

- (5) Match up a front mark on base unit with that on sensor unit.

- ① Put a sensor unit into a base unit from front mark side.

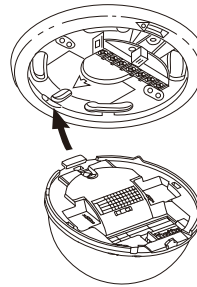

- ② Push sensor unit until release lever will clicks.

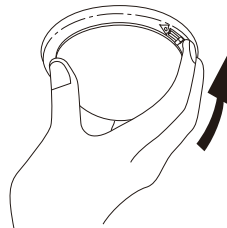

- (6) When sensor unit is detached, hold it and slide release lever as illustrated.

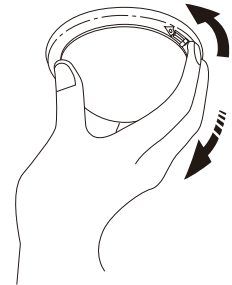

- (7) When sensor unit is locked, tighten the locking screw.

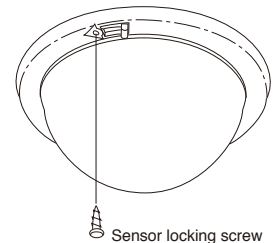

5 WIRING

[Terminal arrangement]

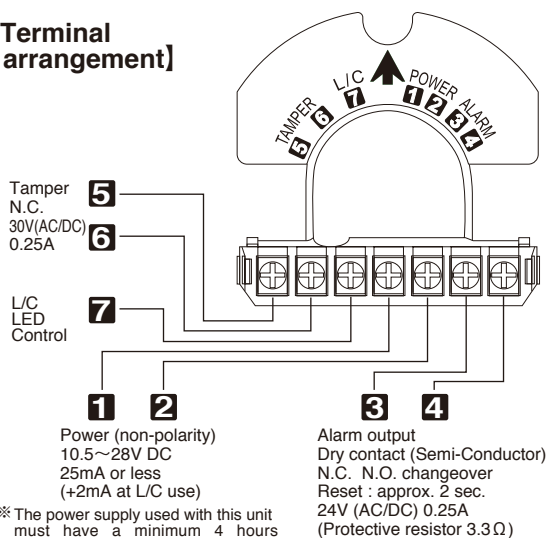

[Basic connection]

(When two units are used)

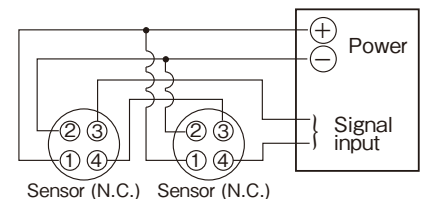

[Allowable wiring distance between sensor and power source]

Size of wire used	Distance at 12VDC
AWG 22 (Dia. 0.65mm)	820 ft. (250m)
AWG 20 (Dia. 0.80mm)	1476 ft. (450m)
AWG 18 (Dia. 1.00mm)	2296 ft. (700m)

Note 1) The maximum wire length, when two or more units are connected, is the above distance divided by the number of units.

2) The protection circuit can be wired to a distance of 3,280 ft (1,000m) with AWG 22 (0.65mm dia.) wire.

* Allow approx. one minute for warm-up after power is applied. (Alarm LED is flashing) In the meantime, an alarm is not initiated.

* After the one minute has passed the unit will be in the armed condition and will trigger when detecting a human body.

* All wiring should be in accordance with the national electric code NFPA-70.

6 PATTERN SETTING

[Vertically] The protection area can be set depending on installation height and max. protection distance by the pattern selector on the rear of sensor, referring to the area set chart.
 Note : Alphabet letters appear alternately on the indicator.

▲ UP  DOWN ▼

DISTANCE		10	13	16	20	23	26	30	33	36	40
ft		3.0	4.0	4.9	6.0	7.0	7.9	9.0	10.0	11.0	12.0
m		3.0	4.0	4.9	6.0	7.0	7.9	9.0	10.0	11.0	12.0
HEIGHT	6.5	2.0	F	E	D	C	C	B	A	A	A
	8.5	2.6	H	G	F	E	D	C	B	B	A
	10	3.0	H	H	G	F	E	D	C	C	C
	13	4.0				H	G	F	F	E	E

AREA SET CHART

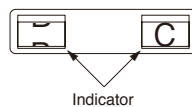

[i.e.]

When the sensor is to protect an area 40' (12m) at 10' (3m) high, turn the pattern selector such that the indicator shows "C".

When the sensor is installed at higher than 10' (3m), there could be some uncovered spaces between the neighboring areas which could cause no detection. Readjust the detection area if you find the sensor cannot achieve proper detection. If you still find the sensor fails to detect even after readjusting the area, switch on the fine motion detection. Please note with the fine motion detection the sensor will be more sensitive to temperature fluctuations or to small animals.

[Horizontally]

Make use of mounting hole for horizontal adjustment. (25° adjustable)

7 OPERATION

- Turn the power ON, and wait for 1 minute until the alarm LED stops flashing.
- Walk test in the protection area to check if an alarm is activated.
 Check on both of the alarm LED and control panel.
- After correct operation has been confirmed, turn the alarm LED OFF with mode selector on the rear of sensor unit.
 (When set at OFF, the alarm LED does not light even if an alarm is activated.)

8 MODE SETTING

Sensor operation can be adjusted by mode selectors on the rear of unit to suit its application / environment.

1 LED	2 MEMORY	3 ALARM	4,5 SENS. (%)	6,7 COUNT	8 FINE MOTION		

(1) Alarm LED ON/OFF

ON : Lights at alarm
 OFF : LED disabled

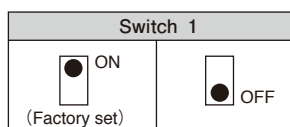

LED CONTROL FUNCTIONS

Wire terminal ⑦ (L/C) through an external control contact switch with Power (-)

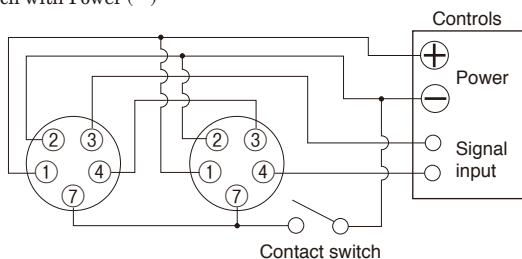

● OPERATION

Turn the Mode selector ① OFF
 When the switch is turned ON, the alarm LED lights at alarm.
 When the switch is turned OFF, the alarm LED does not light.

(2) Changeover of alarm memory

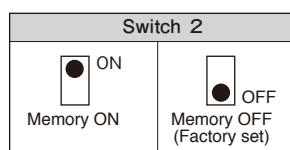

Operation : Memory is always stored when sensor is armed.
 When an alarm has been activated, the memory LED flashes for 3 min. and then remains lit for 47 min. It automatically reset and memory is also canceled.

(3) Changeover of alarm contact

ON : N.O.
 OFF : N.C.

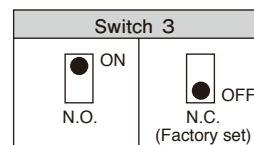

(4) Sensitivity

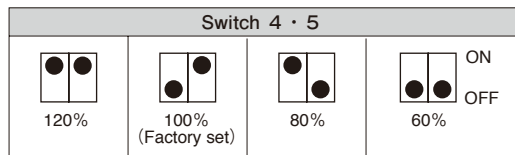

(5) Pulse count

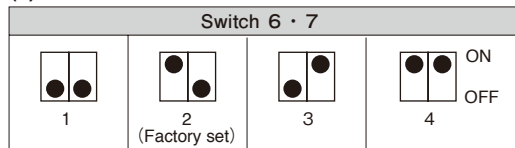

- 1 : Most sensitive.
- 2 : Normally set to this position.
- 3 / 4 : Least sensitive, prevents false alarms caused by temperature fluctuation.

(6) Fine motion detection

This function allows sensor to detect small movements of hands or body in a narrow range.

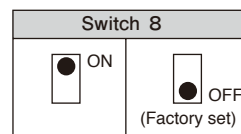

Note 1) : This mode is quite sensitive to detect even slight movement. Its ability to discriminate against small animals such as rodents is low. Therefore this should be taken into consideration when selecting this function.

Note 2) : This function has not been evaluated by UL.

FACTORY SET AT

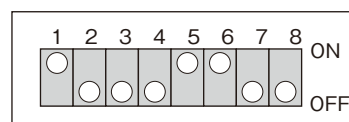

9 TROUBLESHOOTING

Solve possible problems according to the following table. If normal operations cannot be restored by this means, contact either the dealer from whom you bought the unit or TAKEX.

Trouble	Check	Corrective Action
Completely inactive	No power supply, broken wire or improper voltage.	Correct power supply or replace broken wire.
	Not yet 1 minute after power turned on (Alarm LED is flickering.)	Allow for warming up time (about 1 min.)
	Cover shielded by substances (including glass).	Remove the substances.
	Improper area adjustment.	Readjust the protection area setting.
Sometimes inactive	Improper area adjustment.	Readjust the protection area setting.
	Cover face is soiled with dust or water drop.	Clean the cover with soft cloth. (Do not use chemicals such as thinners or alcohol.)
	Is the protection range proper ?	Reposition so that the range is proper.
Activated when no person has passed	Unstable power voltage.	Stabilize the power voltage.
	Something moving in protected area or too rapid temperature variations.	Remove the cause.
	Large electrical noise source such as power machine nearby or its wiring close to that of sensor.	Relocate device.
	Intense reflection of sun light or head light shining on the sensor.	Relocate device. Shield with a blind.
	Is the sensor reacting to passersby outside ?	Readjust the protection area.
The alarm LED lights, but connected units are inactive	Poor contact output connection or broken wire or short circuit.	Check the wiring or connection.
	Contact output is not working.	Check the contact output terminal using a tester.
	Is the connected unit operation normal ?	Check the connected unit.

10 SPECIFICATIONS

Model	PA-6612E
Detection system	Passive infrared
Coverage	Wide angle 40' (12m) Max.
Sensitive zone	17 pairs (64)
Supply voltage	10.5~28V DC (non-polarity)
Current consumption	25mA Max. (+2mA at L/C use)
Alarm signal	Dry contact (Semi-Conductor) (N.C. N.O. changeover) Reset : Approx. 2 sec., 24V(AC/DC) 0.25A (protective resistance 3.3Ω)
Alarm memory	3 minutes flashing, 47 minutes lighting and automatically reset
Alarm LED	Red : Flashing at warming up Lighting at alarm (LED disabled)
Memory LED	Yellow : Flashing at memory activated Lighting at memory indication
Adjustment	Vertically 19.5°, Horizontally 25° (on mounting hole of base)
Count changeover	1 / 2 / 3 / 4 changeover
Fine motion detection	Slight movements of human beings can be detected
Ambient temperature range	+5° F to +131° F (-15° C to +55° C) without condensation
Mounting position	Indoor ceiling (wall mount with optional attachment BCW-401)
Wiring connection	Terminals on separate base unit
Weight	4.73oz (135g)
Appearance	Thermo plastic resin
Accessory	Tapping screw : 2 pcs. Sensor locking screw : 1 pce.

The specifications are subject to change without notice.

Limited Warranty :

TAKEX products are warranted to be free from defects in material and workmanship for 12 months from original date of shipment. Our warranty does not cover damage or failure caused by natural disasters, abuse, misuse, abnormal usage, faulty installation, improper maintenance or any repairs other than those provided by TAKEX. All implied warranties with respect to TAKEX, including implied warranties for merchantability and implied warranties for fitness, are limited in duration to 12 months from original date of shipment. During the Warranty Period, TAKEX will repair or replace, at its sole option, free of charge, any defective parts returned prepaid. Please provide the model number of the products, original date of shipment and nature of difficulty being experienced. There will be charges rendered for product repairs made after our Warranty Period has expired.

11 EXTERNAL DIMENSIONS

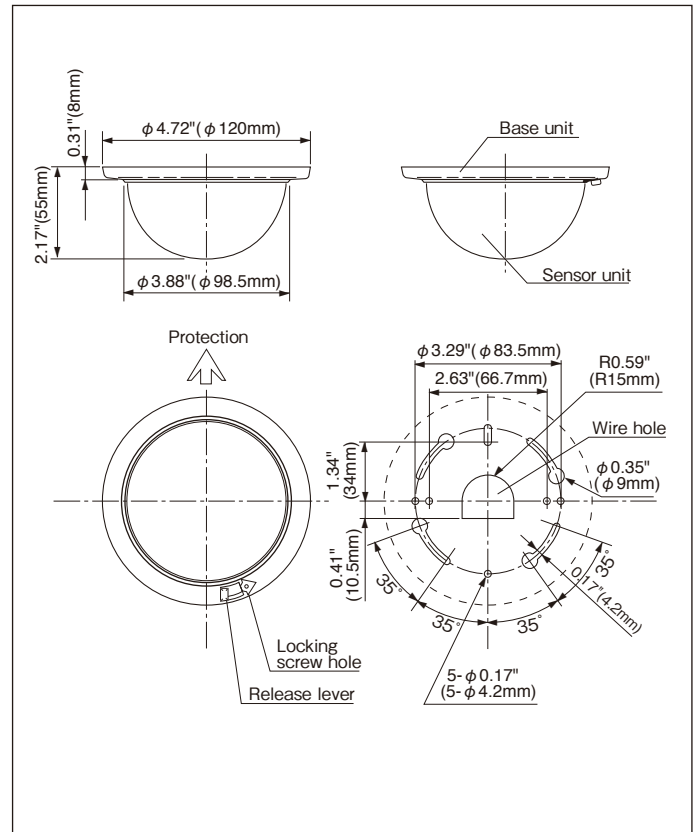

TAKEX TAKENAKA ENGINEERING CO., LTD.

In Japan

Takekaka Engineering Co., Ltd.
83-1, Gojo-sotokan, Higashino,
Yamashina-ku, Kyoto 607-8156, Japan
Tel : 81-75-501-6651
Fax : 81-75-593-3816
http : // www. takex-eng. co. jp /

In the U.S.

Takek America Inc.
151, San Zeno WAY
Sunnyvale, CA 94086, USA
Tel : 408-747-0100
Fax : 408-734-1100
http : // www. takex. com

In Australia

Takek America Inc.
4/15 Howleys Road, Notting Hill,
VIC, 3168
Tel : +61 (03) 9544-2477
Fax : +61 (03) 9543-2342

In the U.K.

Takek Europe Ltd.
Aviary Court, Wade Road,
Basingstoke, Hampshire. RG24 8PE, U.K.
Tel : (+44) 01256-475555
Fax : (+44) 01256-466268
http : // www. takex. com