

TAKEX

TWIN MIRROR PASSIVE INFRARED SENSOR

Wide angle protection : PA-6614E · PA-6614E(BL) : Black color

Instruction Manual

We appreciate your purchase of a TAKEX passive infrared sensor. This sensor will provide long and dependable service when properly installed. Please read this Instruction Manual carefully for correct and effective use.

Please Note : This sensor is designed to detect intrusion and to initiate an alarm ; it is not a burglary-preventing device.

TAKEX is not responsible for damage, injury or losses caused by accident, theft, Acts of God (including inductive surge by lightning), abuse, misuse, abnormal usage, faulty installation or improper maintenance.

1 PRODUCT DESCRIPTION

- PA-6614E is a passive infrared sensor that detects far-infrared energy emitted from the human body and outputs an alarm signal.
- A new detection system that combines the twin mirror system and the second generation fuzzy processing improve a detection performance and reduce a false detection by small animals, and stable operation is possible in wide range of installation locations.
- Detection distance up to 14m(46')
- Mounting height up to 6m(19') in "High density mode" (*Max 5m(16') in "Standard mode")
- Lower current consumption makes it possible to use a power supply with a smaller capacity than before.

2 PARTS DESCRIPTION

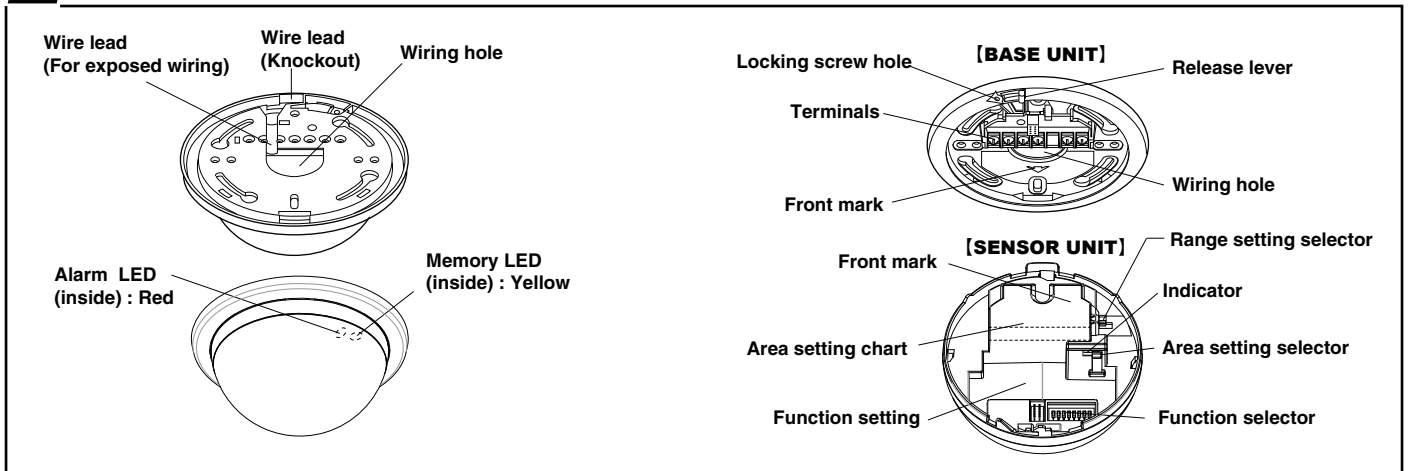

3 COVERAGE

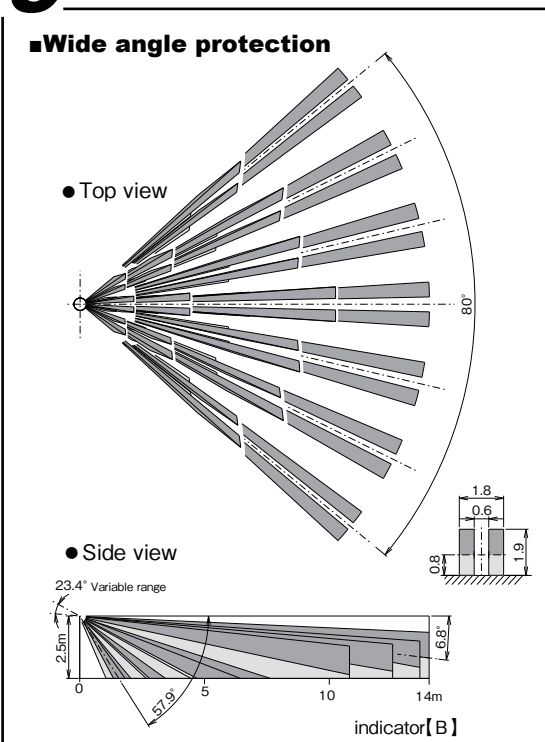

4 DO'S AND DON'T'S

- Install the sensor in a location where intruders are more likely to cross the protection zones, rather than approach head on.
- Avoid direct sunlight, spot light or intense reflections on the sensor or the protection zone.
- Do not install in a location which is subject to electrical noise or intense vibration.
- Do not install the sensor outdoors (indoor only).

[MAINTENANCE]

- The passive infrared sensor is designed to detect infrared energy variations caused by the presence of a human body. Therefore, note that similar variations in conditions in protection area, due to other reasons, may cause the sensor to create an alarm as it is unable to distinguish between sources.

1. When the unit is soiled, clean the cover with a soft cloth moistened with a small amount of cleansing solution.
Do not use chemicals such as thinners or alcohol.
2. Check operation once a week.
Do not fail to check operation whenever furniture in coverage area is moved.

5 INSTALLATION

- (1) Slide release lever to a direction that an arrow points to detach sensor unit from base unit.

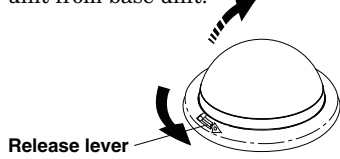

- (2) Mount the base on the ceiling with screws. Fix so that the front mark (↑) is pointing to the center of protection area.

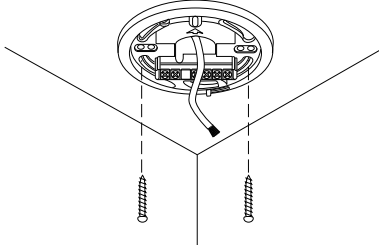

* Break knockout and put the wire through wire lead on base unit, when exposed wiring.

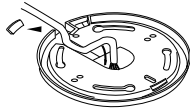

- (3) Connect the wires to the terminals referring to the paragraph on "6.WIRING".
- (4) Set the protection area referring to the paragraph on "7.AREA ADJUSTMENT AND OPERATION MODE SETTING".

- (5) Match up a front mark on base unit with that on sensor unit. Put a sensor unit into a base unit from front mark side.

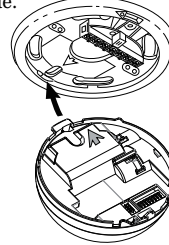

Push sensor unit until release lever will click.

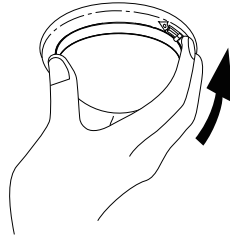

- (6) When sensor unit is detached, hold it and slide release lever as illustrated.

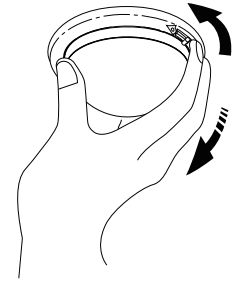

- (7) When sensor unit is locked, tighten the locking screw.

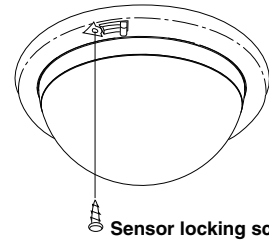

6 WIRING

[Terminal arrangement]

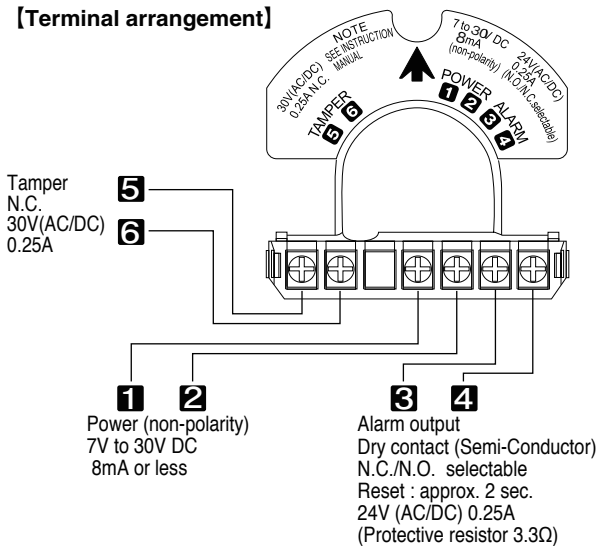

[Basic connection]

[When two units are used]

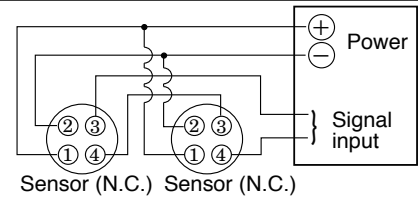

[Allowable wiring distance between sensor and power source]

Size of wire used	Distance at 12VDC
AWG 22	2,900m (9,500 ft.)
AWG 20	4,700m (15,500 ft.)
AWG 18	7,400m (24,500 ft.)

Note

- The maximum wire length, when two or more units are connected, is the above distance divided by the number of units.
 - The protection circuit can be wired to a distance of 2,900m (9,500 ft.) with AWG 22 wire.
- * Wait approx. one minute for warm-up after power is applied. (Alarm LED is flashing) In the meantime, an alarm is not initiated.
- * After the one minute has passed the unit will be in the armed condition and will trigger the alarm when detecting a human body.

7 AREA ADJUSTMENT AND OPERATION MODE SETTING

Please set "1. Detection area" and "2. Operation mode" properly according to the installation conditions (ceiling height and Max. detection distance) and operation conditions.

1. Detection area setting

Set the "Area setting selector" and "Range setting selector" based on "Area setting chart" as a guide.

Area setting selector

Alphabet "A" to "J" appears in the "Indicator" by moving the area setting selector up and down. Select the alphabet based on detection area condition.

Range setting selector

Select "Range ①" or "Range ②" according to the color of selected alphabet from "Area setting chart".
* Gray color : Range ①, White color : Range ② in the Area setting chart.

2. Operation mode setting

Select "Operation mode" with Dip switch 6 and 7 in function selector based on operating condition.

Standard mode ([1] , [2] , [3])	Set "[1] , [2] , [3]" according to the selected alphabet in above "Detection area setting".
High density mode	This mode detects even small movements of the human body and can be operated over a wide range beyond the standard mode setting range. * When operating in this mode, set the Range setting selector to "White color" regardless of the installation conditions.

[Back side of sensor unit]

⚠ Note
The area setting chart displayed on the back of the sensor unit is for "Standard mode".
For the high density mode, refer to the area set chart of "High density mode" at the right and set the indicator.

Area setting chart "Standard mode"

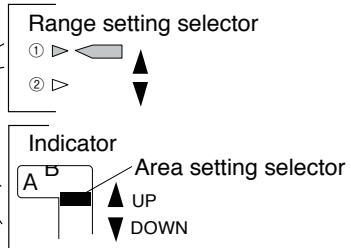
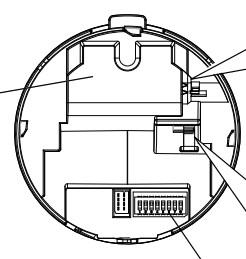

Function selector "Dip switch 6,7 : Operation mode"

Area setting chart "Standard mode"

MODE	[1]	[2]	[3]
DISTANCE (m)	3 4 5 6 7 8 9 10 11 12 13 14		
DISTANCE (ft)	10 13 16 20 23 26 29 33 36 40 42 46		
HEIGHT (m)	2.0 2.5 3.0 3.5 4.0 5.0	G F E D C B B B A A A	
HEIGHT (ft)	6.5 8.5 10 12 14 16	H G F E D C C C B B B	
		H G F E D C C C C C C	
		I H G F E D C C C C C	
		I H G F E D C C C C C	
		J I H G F E D C C C C	
		J I H G F E D C C C C	

Range setting selector
□ Gray color : ①
□ White color : ②

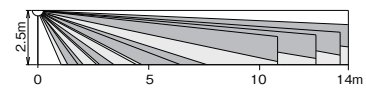

Ex.1) Height : 2.5m(8.5ft) Max. distance : 14m(46ft)
Area setting chart : "B" /Gray, Mode " [3] "

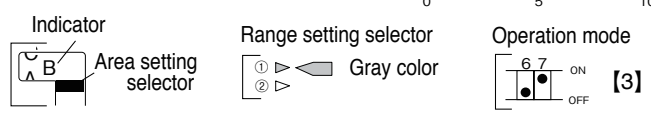

Area setting chart "High density mode"

MODE	HIGH DENSITY												
DISTANCE (m)	3 4 5 6 7 8 9 10 11 12 13 14												
DISTANCE (ft)	10 13 16 20 23 26 29 33 36 40 42 46												
HEIGHT (m)	2.0 2.5 3.0 3.5 4.0 5.0 6.0	G F E D C B B B A A A											
HEIGHT (ft)	6.5 8.5 10 12 14 16 20	H G F E D C C C B B B											
		H G F E D C C C C C C											
		I H G F E D C C C C C											
		I H G F E D C C C C C											
		J I H G F E D C C C C											
		J I H G F E D C C C C											

In case High density mode, select Range >White" in all setting.

Ex.3) Height : 6.0m(20ft) Max. distance : 12m(40ft)
Area setting chart : "I" /White, "High density" mode

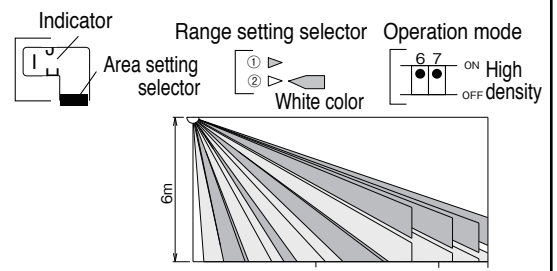

⚠ Note
In High-density mode, the sensor detects small movements of the human body, and the small animal identification performance becomes lower than the standard mode.

⚠ Note
To set the appropriate detection area, adjust "Area setting selector/ Range setting selector /Function selector" appropriately according to the "Area setting chart". Inappropriate selection may reduce performance of human body detection and small animal identification.

[For horizontal adjustment] Make use of mounting hole of base. (25° adjustable)

8 FUNCTION SETTING

Sensor operation can be adjusted by Function selector on the back of unit to suit its application / environment.

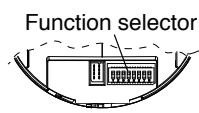

FUNCTION SETTING

1 LED	2 MEMORY	3 ALARM	4,5 SENS. (%)	6,7 OPERATION MODE	8 OUTPUT TIME
ON	ON	N.O.	120 80	[1] [3]	5 min
OFF	OFF	N.C.	100 60	[2] High density	2 sec

(1) ALARM LED

ON : Lights at alarm
OFF : LED off

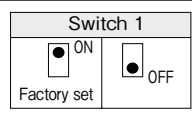

(2) ALARM MEMORY

Operation :
Memory is always stored when sensor is armed. When an alarm has been activated, the memory LED flashes for 3 min. and then remains lit for 47 min. It automatically reset and memory is also canceled.

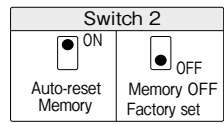

(3) ALARM CONTACT

ON : N.O.
OFF : N.C.

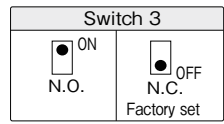

(4) SENSITIVITY

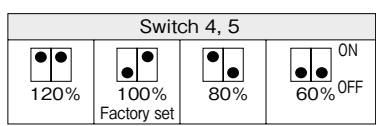

(5) OPERATION MODE

Standard mode [1] [2] [3]
Set according to the area setting chart for stable detection performance.

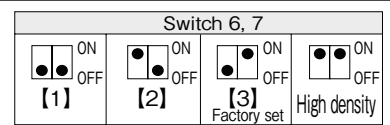

High density mode

Use this setting when the ceiling is high and beyond standard operation, or when you want to detect sensitively even small movements of the human body. By selecting this mode, small animal identification performance and stability against temperature changes will be lower than other settings.

(6) OUTPUT TIME

ON : 5 min latch time after detection
OFF : 2 sec (one shot) after detection

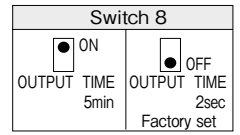

Other functions

Self-diagnosis function : The sensor unit detects a failure of pyroelectric element or a disconnection inside and continuously notifies it as a failure alarm.
Temperature compensate : This function stabilizes the detection performance by measuring the ambient temperature of the sensor.

9 OPERATION CHECK

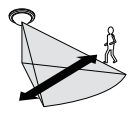

- Turn the power ON, and wait 1 minute until the alarm LED stops flashing.
- Walk test in the protection area to check if an alarm is activated. Check on both of the alarm LED and control panel.
- After correct operation has been confirmed, turn the alarm LED OFF with mode selector on the back of sensor unit. (When set at OFF, the alarm LED does not light even if an alarm is activated.)

10 TROUBLESHOOTING

Solve possible problems according to the following table. If normal operations cannot be restored by this means, contact either the dealer from whom you bought the unit or TAKEX.

Trouble	Check	Corrective Action
Completely inactive	(1)No power supply, broken wire or improper voltage. (2)Not yet 1 minute after power turned on (Alarm LED is flickering.) (3)Cover shielded by substances (including glass). (4)Improper area adjustment.	(1)Correct power supply or replace broken wire. (2)Allow for warming up time (about 1 min.) (3)Remove the substances. (4)Readjust the protection area setting.
Sometimes inactive	(1)Improper area adjustment. (2)Cover face is soiled with dust or water drop. (3)Is the protection range proper ? (4)Small temperature difference between people and back ground.	(1)Readjust the protection area setting. (2)Clean the cover with soft cloth. (Do not use chemicals such as thinners or alcohol.) (3)Reposition so that the range is proper. (4)Set sensitivity 120%
Activated when no person has passed	(1)Something moving in protected area or too rapid temperature variations. (2)Large electrical noise source such as power machine nearby or its wiring close to that of sensor. (3)Intense reflection of sun light or head light shining on the sensor. (4)Is the sensor reacting to passersby outside ?	(1)Remove the cause. (2)Relocate device. (3)Relocate device. Shield with a blind. (4)Readjust the protection area.
The alarm LED lights, but connected units are inactive	(1)Poor contact output connection or broken wire or short circuit. (2>Contact output is not working. (3)Is the connected unit operation normal ?	(1)Check the wiring or connection. (2)Check the contact output terminal using a tester. (3)Check the connected unit.
The alarm LED lights and alarm signal output continuously	(1)Self-diagnosis error.	(1)Check for disconnection or damage inside the device.

11 SPECIFICATIONS

Model	PA-6614E	PA-6614E(BL)
Detection system	Passive infrared (Twin mirror)	
Coverage	Wide angle 14m Max.	
Sensitive zone	38 pairs	
Supply voltage	7 to 30V DC (non-polarity)	
Current consumption	8mA Max.	
Alarm signal	Dry contact (Semi-Conductor) (N.C. / N.O. selectable) Reset : Approx. 2 sec., 24V (AC/DC) 0.25A (protective resistor 3.3Ω)	
Alarm memory	3 minutes flashing, 47 minutes lighting and automatically reset. (ON/OFF selectable)	
Alarm LED	Red : Flashing at warming up Lighting at alarm (LED can be disabled)	
Memory LED	Yellow : Flashing at memory activated Lighting at memory indication	
Tamper	N.C. 30V(AC/DC)0.25A	
Adjustment	Vertically : 23° Horizontally : 25° (on mounting hole of base)	
Sensitivity changeover	60% / 80% / 100% / 120% changeover	
Other functions	Self-diagnosis function Temperature compensate	
Ambient temperature range	-15°C to +55°C (+5° F to +131° F) without condensation	
Mounting position	Indoor ceiling (wall mount with optional attachment BCW-401)	
Wiring connection	Terminals on separate base unit	
Weight	120g (4.23oz)	
Appearance	Body /Cover : White resin	Body /Cover : Black resin
Accessory	Tapping screw : 2 pcs. Sensor locking screw : 1 pce.	

12 EXTERNAL DIMENSIONS

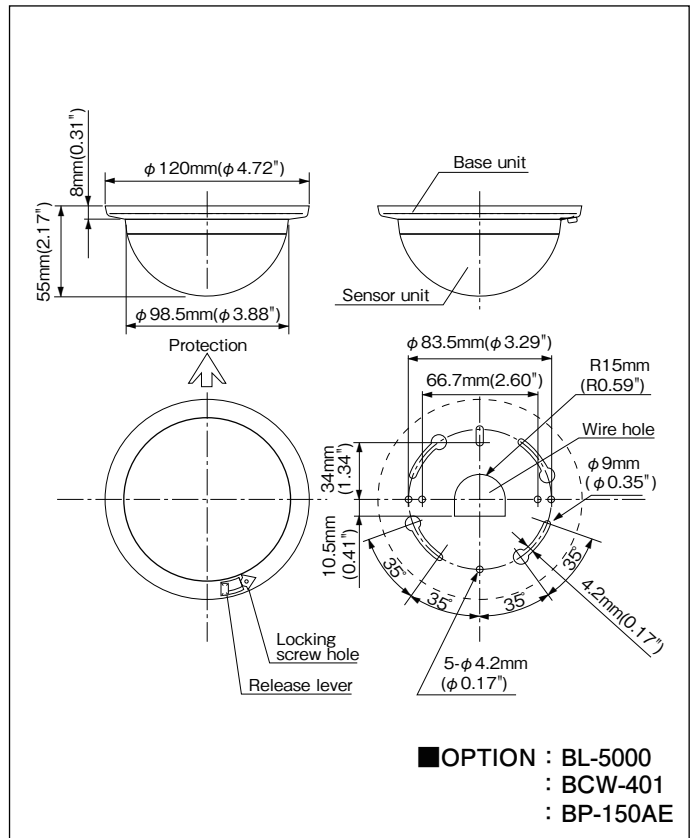

The specifications are subject to change without notice.

Limited Warranty :

TAKEX products are warranted to be free from defects in material and workmanship for 12 months from original date of shipment. Our warranty does not cover damage or failure caused by Acts of God (including inductive surge by lightning), abuse, misuse, abnormal usage, faulty installation, improper maintenance or any repairs other than those provided by TAKEX. All implied warranties with respect to TAKEX, including implied warranties for merchantability and implied warranties for fitness, are limited in duration to 12 months from original date of shipment. During the Warranty Period, TAKEX will repair or replace, at its sole option, free of charge, any defective parts returned prepaid. Please provide the model number of the products, original date of shipment and nature of difficulty being experienced. There will be charges rendered for product repairs made after our Warranty period has expired.

TAKEX TAKENAKA ENGINEERING CO., LTD.

In Japan
Takenaka Engineering Co., Ltd.
 83-1, Gojo-Dori, Sotokan Nishi-iru, Higashino,
 Yamashina-ku, Kyoto 607-8156, Japan
 Tel : 81-75-501-6651
 Fax : 81-75-593-3816
<https://www.takex-eng.co.jp/>

In the U.S.
Takex America Inc.
 151, San Zeno WAY
 Sunnyvale, CA 94086, USA
 Tel : 408-747-0100
 Fax : 408-734-1100
<https://www.takex.com>

In Australia
Takex America Inc.
 4/15 Howleys Road, Notting Hill,
 VIC, 3168
 Tel : +61 (03) 9544-2477
 Fax : +61 (03) 9543-2342
<https://www.takex.com>

In the U.K.
Takex Europe Ltd.
 Aviary Court, Wade Road,
 Basingstoke, Hampshire. RG24 8PE, U.K.
 Tel : (+44) 01256-475555
 Fax : (+44) 01256-466268
<https://www.takex.com>